

# 1. ČELIČNA UŽADI I LANCI

Wire ropes and chains



## 1.1. Opće informacije

**RX-lift**

Smjer pletenja čeličnog užeta:

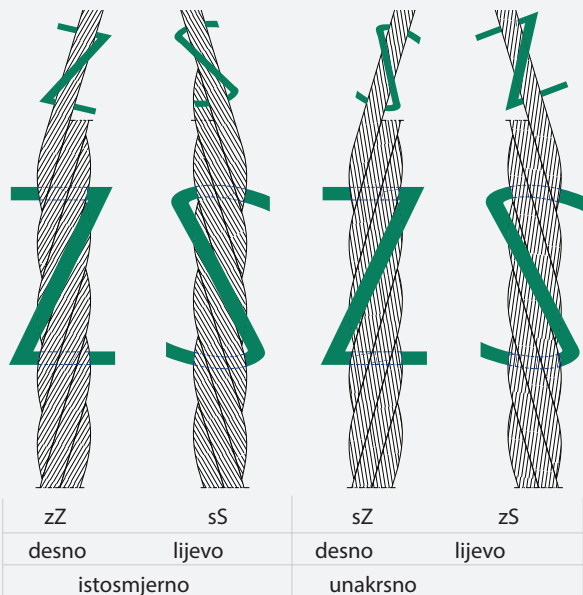

Mjerenje promjera čel. užeta:

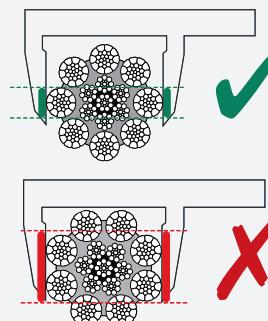

Provjera promjera čel. užeta na užnici:

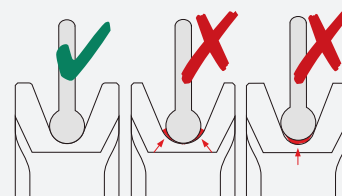

Smjer čel. užeta i namatanje na bubanj:

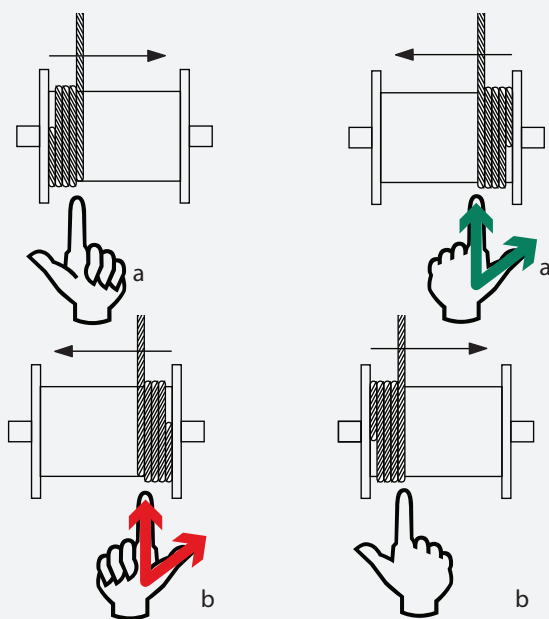

a = lijeva ruka, lijevo použeno uže  
b = desna ruka, desno použeno uže

Vrsta jezgre čeličnog užeta:

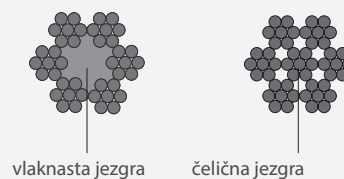

Lubrikacija čeličnog užeta:

Tipovi lubrikacije	Metoda mašćenja	Primjer lubrikacije
Suho	Bez mašćenja, vrlo malo ulja	
A-1	Uljeno + maščene žice unutar strukova kova,	
A-2	Uljeno + maščene žice unutar strukova kova, jezgra strukovi unutar jezgre čel. užeta	
A-3	Maščene žice unutar i oko strukova, maščena jezgra čel. užeta	

Različite konstrukcije i obrada čel. užeta, zavisno od namjene:

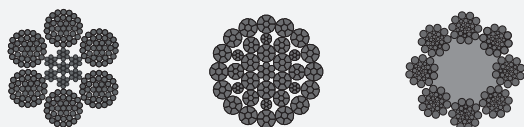

# 1. ČELIČNA UŽADI I LANCI

## Wire ropes and chains

### 1.2. Opća namjena

Čelično uže: 6x7+ vlaknasta jezgra

Wire rope: 6x7+ FC

CE 2.1 2.2 3.1 BL

Promjer (mm)	Min. prekidna sila (kN) 1770 N/mm <sup>2</sup>	Težina (kg/ 100 m)
Diameter	MBL	Weight
2	2.35	1.38
3	5.29	3.11
4	9.40	5.52
5	14.70	8.63
6	21.20	12.40
7	28.80	16.90
8	37.60	22.10
9	47.60	27.90
10	58.80	34.50
11	71.10	41.70
12	84.60	49.70
13	99.30	58.30
14	115.00	67.60
16	150.00	88.30
18	190.00	112.00
20	235.00	138.00

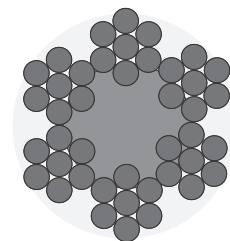

- EN 12385-4
- DIN 3055
- završna obrada: el. galvanizirano ili vruće cinčano
- čvrstoća žice: 1770 N/mm<sup>2</sup>

Čelično uže: 6x7 + čelična jezgra

Wire rope: 6x7 + IWRC

CE 2.1 2.2 3.1 BL

Promjer (mm)	Min. prekidna sila (kN) 1770 N/mm <sup>2</sup>	Težina (kg/ 100 m)
Diameter	MBL	Weight
2	2,54	1,54
3	5,72	3,46
4	10,20	6,14
5	15,90	9,60
6	22,90	13,80
7	31,10	18,80
8	40,70	24,6
9	51,50	31,1
10	63,5	38,4
11	76,90	46,5
12	91,50	55,30
13	107,0	64,9
14	125,0	75,30
16	163,0	98,3
18	206,0	124,0
20	254,0	154,0

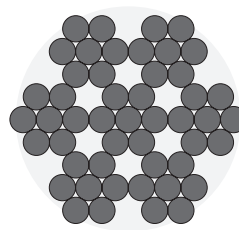

- EN 12385-4
- DIN 3055
- završna obrada: el. galvanizirano ili vruće cinčano
- čvrstoća žice: 1770 N/mm<sup>2</sup> ili 1960 N/mm<sup>2</sup>

# 1. ČELIČNA UŽAD I LANCI

## Wire ropes and chains

### 1.2. Opća namjena

Čelično uže: 6x19 + vlaknasta jezgra

Wire rope: 6x19 + FC

CE 2.1 2.2 3.1 BL

Promjer (mm)	Min. prekidna sila (kN) 1770 N/mm <sup>2</sup>	Min. prekidna sila (kN) 1960 N/mm <sup>2</sup>	Težina (kg/100 m)
Diameter	MBL	MBL	Weight
3	4,89	5,42	3,11
4	8,69	9,63	5,54
5	13,60	15,0	8,65
6	19,60	21,7	12,50
7	26,6	29,50	17,0
8	34,8	38,5	22,1
9	44,0	48,70	28,0
10	54,3	60,20	34,60
11	65,8	72,8	41,9
12	78,3	86,70	49,80
13	91,8	101,7	58,50
14	107,0	118,0	67,80
16	139,0	154,0	88,60
18	176,0	195,0	112,0
20	217,0	241,0	138,0
22	263,0	291,0	168,0
24	313,0	347,0	199,0
26	367,0	407,0	234,0
28	426,0	472,0	271,0
32	556,0	616,0	354,0
36	704,0	780,0	448,0
40	869,0	963,0	554,0

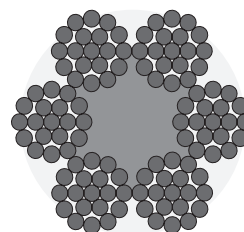

- EN 12385-4
- DIN 3060
- završna obrada: el. galvanizirano ili vruće cinčano
- čvrstoća žice: 1770 N/mm<sup>2</sup> ili 1960 N/mm<sup>2</sup>

Čelično uže: 6x19 + čelična jezgra

Wire rope: 6x19 + IWRC

CE 2.1 2.2 3.1 BL

Promjer (mm)	Min. prekidna sila (kN) 1770 N/mm <sup>2</sup>	Min. prekidna sila (kN) 1960 N/mm <sup>2</sup>	Težina (kg/100 m)
Diameter	MBL	MBL	Weight
3	5,77	6,39	3,43
4	10,30	11,4	6,1
5	16,0	17,7	9,53
6	23,1	25,5	13,7
7	34,4	34,8	18,7
8	41,0	45,4	24,4
9	51,9	57,5	30,90
10	64,1	71,10	38,1
11	77,5	85,90	46,1
12	92,3	102,2	54,9
13	108,3	119,90	64,4
14	126,0	139,0	74,7
16	164,0	182,0	97,5

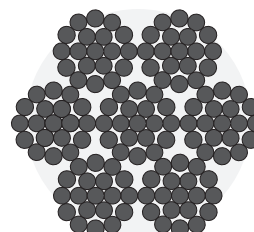

- EN 12385-4
- DIN 3060
- završna obrada: el. galvanizirano ili vruće cinčano
- čvrstoća žice: 1770 N/mm<sup>2</sup> ili 1960 N/mm<sup>2</sup>

# 1. ČELIČNA UŽADI I LANCI

## Wire ropes and chains

### 1.2. Opća namjena

Čelično užje: 6x37+ vlaknasta jezgra

Wire rope: 6x37 + FC

CE 2.1 2.2 3.1 BL

Promjer (mm)	Min. prekidna sila (kN) 1770 N/mm <sup>2</sup>	Min. prekidna sila (kN) 1960 N/mm <sup>2</sup>	Težina (kg/ m)
Diameter	MBL	MBL	Weight
5.00	13.1	14.5	0.085
6.00	18.8	20.8	0.125
7.00	25.6	28.3	0.170
8.00	33.4	37.0	0.221
9.00	42.3	46.8	0.280
10.00	52.2	57.8	0.346
11.00	63.1	70.0	0.419
12.00	75.1	83.3	0.498
13.00	88.2	97.7	0.585
14.00	102	113	0.678
15.00	118	131	0.782
16.00	134	148	0.886
17.00	152	168	1.003
18.00	169	187	1.120
19.00	189	209	1.250
20.00	209	231	1.38
21.00	231	256	1.52
22.00	253	280	1.67
23.00	277	307	1.83
24.00	301	333	1.99
25.00	327	362	2.16
26.00	353	391	2.34
27.00	381	422	2.52
28.00	409	453	2.71
30.00	472	523	3.12
32.00	534	591	3.54
34.00	605	670	4.01
35.00	641	710	4.24
36.00	676	749	4.48
38.00	756	837	5.01
40.00	835	925	5.54
42.00	923	1022	6.12
44.00	1010	1118	6.70
45.00	1058	1172	7.01
46.00	1105	1224	7.33
47.00	1153	1277	7.65
48.00	1200	1329	7.97
50.00	1305	1445	8.66
51.00	1358	1504	9.01
52.00	1410	1561	9.36
54.00	1525	1689	10.10
55.00	1583	1753	10.50
56.00	1640	1816	10.90
57.00	1700	1882	11.30
58.00	1760	1949	11.70
60.00	1880	2082	12.50

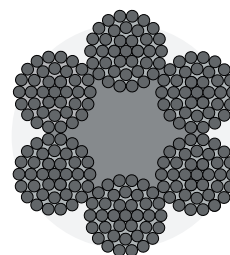

- EN 12385-4
- DIN 3066
- završna obrada: crno, el. galvanizirano ili vruće cinčano
- čvrstoća žice: 1770 N/mm<sup>2</sup> ili 1960 N/mm<sup>2</sup>
- opća namjena, obično se koristi kod priveza i izrade čel. priveznica



# 1. ČELIČNA UŽAD I LANCI

## Wire ropes and chains

### 1.2. Opća namjena

Čelično uže: 6x37 + čelična jezgra

Wire rope: 6x37 + IWRC

CE 2.1 2.2 3.1 BL

Promjer (mm)	Min. prekidna sila (kN) 1770 N/mm <sup>2</sup>	Min. prekidna sila (kN) 1960 N/mm <sup>2</sup>	Težina (kg/m)
Diameter	MBL	MBL	Weight
4.50	11.4	12.7	0.077
5.00	14.1	15.6	0.095
6.00	20.3	22.5	0.13
7.00	27.6	30.6	0.18
8.00	36.1	40.0	0.24
9.00	45.7	50.6	0.30
10.00	56.4	62.5	0.38
11.00	68.2	75.5	0.46
12.00	81.2	89.9	0.54
13.00	95.2	105.4	0.64
14.00	110	122	0.74
15.00	127	141	0.86
16.00	144	159	0.97
17.00	164	182	1.10
18.00	183	203	1.23
19.00	204	226	1.37
20.00	225	249	1.52
21.00	249	276	1.68
22.00	273	302	1.84
23.00	299	331	2.01
24.00	325	360	2.19
25.00	353	391	2.38
26.00	381	422	2.57
27.00	412	456	2.77
28.00	442	489	2.98
30.00	510	565	3.44

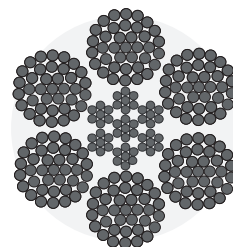

- EN 12385-4
- DIN 3066
- završna obrada: crno, el. galvanizirano ili vruće cinčano
- čvrstoća žice: 1770 N/mm<sup>2</sup> ili 1960 N/mm<sup>2</sup>



Čelično uže: 6x24 + vlaknasta jezgra

Wire rope: 6x24+ FC

CE 2.1 2.2 3.1 BL

Promjer (mm)	Min. prekidna sila (kN) 1570 N/mm <sup>2</sup>	Težina (kg/100 m)
Diameter	MBL	Weight
10	44.9	31.4
12	64.0	45.2
14	88.0	61.5
16	115.0	80.4
18	145.0	102
20	180.0	126
22	217.0	152
24	259.0	181
26	30.4	212
28	352.0	246

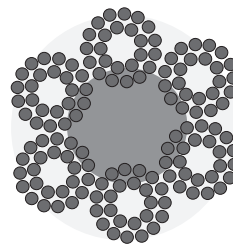

- EN 12385-4
- uže za lashing
- DIN 3068
- završna obrada: crno, el. galvanizirano ili vruće cinčano
- čvrstoća žice: 1570 N/mm<sup>2</sup>

# 1. ČELIČNA UŽADI I LANCI

# Wire ropes and chains

## 1.2. Opća namjena

Čelično uže: 6x36WS + vlaknasta jezgra

Wire rope: 6x36WS+ FC

CE 2.1 2.2 3.1 BL

Promjer (mm)	Min. prekidna sila (kN) 1770 N/mm <sup>2</sup>	Min. prekidna sila (kN) 1960 N/mm <sup>2</sup>	Težina (kg/100 m)
Diameter	MBL	Weight	MBL
8	37,40	41,4	23,50
9	47,30	52,40	29,7
10	58,4	64,7	36,7
11	70,70	78,30	44,4
12	84,1	93,10	52,8
13	98,7	109,0	62,0
14	114,0	127,0	71,9
16	150,0	166,0	94,0
18	189,0	210,0	119,0
20	234,0	259,0	147,0
22	283,0	313,0	178,0
24	336,0	373,0	211,0
26	395,0	437,0	248,0
28	458,0	507,0	288,0
30	526,0	582,0	330,0
32	598,0	662,0	376,0
36	757,0	838,0	476,0
38	843,0	934,0	530,0
40	935,0	1040,0	587,0
44	1130,0	1250,0	711,0
48	1350,0	1490,0	846,0
52	1580,0	1750,0	992,0
56	1830,0	2030,0	1150,0
60	2100,0	2330,0	1320,0

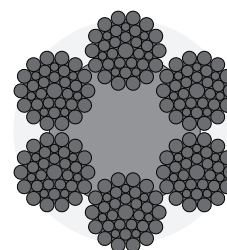

- EN 12385-4
- DIN 3064
- završna obrada: crno, el. galvanizirano ili vruće cinčano
- čvrstoća žice: 1770 N/mm<sup>2</sup> ili 1960 N/mm<sup>2</sup>

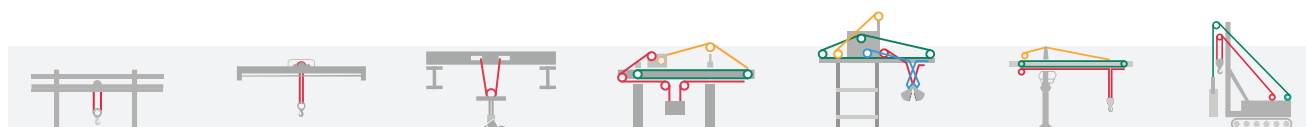

# 1. ČELIČNA UŽAD I LANCI

# Wire ropes and chains

## 1.2. Opća namjena

Čelično užje: 6x36WS+čelična jezgra

Wire rope: 6x36WS+ IWRC

CE 2.1 2.2 3.1 BL

Promjer (mm)	Min. prekidna sila (kN) 1960 N/mm <sup>2</sup>	Min. prekidna sila (kN) 2160 N/mm <sup>2</sup>	Težina (kg/100 m)
Diameter	MBL	MBL	Weight
6	25	28	15
8	45	49	26
9	57	62	33
10	70	77	41
11	84	93	49
12	100	111	59
13	118	130	69
14	137	151	80
15	157	173	92
16	179	197	105
17	202	222	118
18	226	249	133
19	252	278	148
20	279	308	164
21	308	339	180
22	338	372	198
23	369	407	216
24	402	443	236
25	436	481	256
26	472	520	276
27	509	561	298
28	547	603	321
29	587	647	344
30	628	692	368
32	715	787	419
34	807	889	473
36	904	997	530
38	1008	1110	591
40	1116	1230	654
42	1231	1356	721
44	1351	1489	792
46	1476	1627	865
48	1608	1772	942
50	1744	1922	1023
52	1887	2079	1106
54	2035	2242	1193
56	2188	2411	1283
58	2347	2587	1376
60	2512	2768	1472
62	2682	2956	1572
66	3039	3350	1782
70	3419	3768	2004

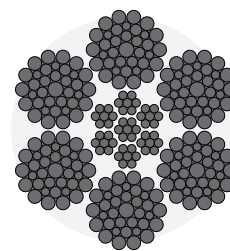

- EN 12385-4
- DIN 3064
- završna obrada: crno, el. galvanizirano ili vruće cinčano
- čvrstoća žice: 1960 N/mm<sup>2</sup> ili 2160 N/mm<sup>2</sup>

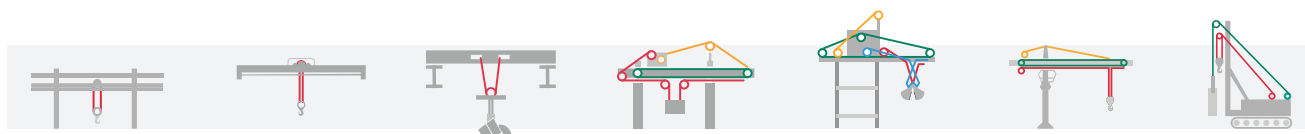

# 1. ČELIČNA UŽADI I LANCI

## Wire ropes and chains

### 1.2. Opća namjena

Čelično užje: 6xK36ws+čelična jezgra KOMPAKTNO

Wire rope: 6x36WS+ IWRC, COMPACTED

CE 2.1 2.2 3.1 BL

Promjer (mm)	Min. prekidna sila (kN) 1960 N/mm <sup>2</sup>	Min. prekidna sila (kN) 2160 N/mm <sup>2</sup>	Težina (kg/100m)
Diameter	MBL	MBL	Weight
10	85	91	45
11	103	110	55
12	122	131	65
13	144	154	76
14	167	178	89
15	191	205	102
16	218	233	114
17	246	263	128
18	275	295	144
19	307	329	160
20	340	364	178
22	411	440	215
24	490	524	256
26	561	602	303
28	651	698	351
30	747	801	403

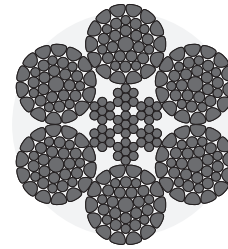

- EN 12385-4
- DIN 3064
- završna obrada: crno, el. galvanizirano ili vruće cinčano
- čvrstoća žice: 1960 N/mm<sup>2</sup> ili 2160 N/mm<sup>2</sup>

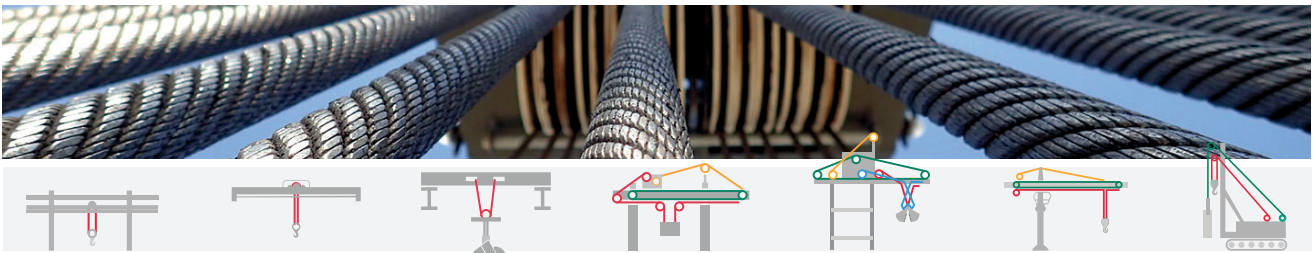

Čelično užje: 6x26WS+ čelična jezgra, dvostruko prešano

Wire rope: 6x26WS+ IWRC, SUPER swaged

CE 2.1 2.2 3.1 BL

Promjer (mm)	Min. prekidna sila (kN) 1960 N/mm <sup>2</sup>	Težina (kg/100 m)
Diameter	MBL	Weight
9	79,0	47,0
10	97,0	56,9
11	121,0	69,0
12	139,0	81,0
13	163,0	96,0
14	189,0	111,0
15	217,0	127,0
16	248,0	145,0
18	310,0	184,0

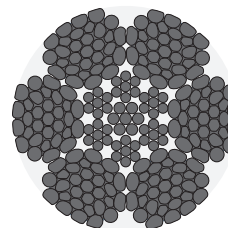

- EN 12385-4
- DIN 3064
- završna obrada: crno, el. galvanizirano ili vruće cinčano
- čvrstoća žice: 1770 N/mm<sup>2</sup>, 1960 N/mm<sup>2</sup> ili 2160 N/mm<sup>2</sup>



# 1. ČELIČNA UŽAD I LANCI

## Wire ropes and chains

### 1.3. Nerotirajuće uže

Čelično uže: 19x7+čelična jezgra

Wire rope: 19x7+IWRC non-rotating, non-compacted

CE 2.1 2.2 3.1 BL

Promjer (mm)	Min. prekidna sila (kN) 1960 N/mm <sup>2</sup>	Težina (kg/100m)
Diameter	MBL	Weight
4	10,30	6,4
5	16,10	10,0
6	23,10	14,4
7	31,5	19,7
8	41,1	25,7
9	52,1	32,50
10	64,3	40,10
11	77,8	48,50
12	92,6	57,70
13	108,7	67,8
14	126,0	79,0
15	145,0	90,0
16	165,0	103,0
18	208,0	130,0
19	232,0	145,0
20	257,0	160,0

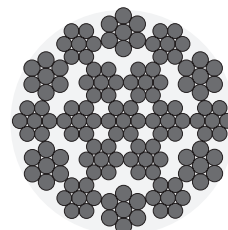

- EN 12385-4
- DIN 3069
- završna obrada: el. galvanizirano ili vruće cinčano
- čvrstoća žice: 1960 N/mm<sup>2</sup>

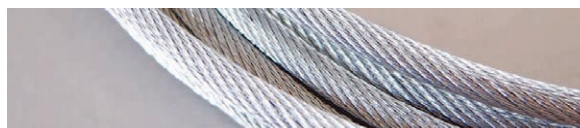

Čelično uže: 35Wx7+čelična jezgra

Wire rope: 35Wx7+IWRC rotation resistant, non-compacted

CE 2.1 2.2 3.1 BL

Promjer (mm)	Min. prekidna sila (kN) 1960 N/mm <sup>2</sup>	Min. prekidna sila (kN) 2160 N/mm <sup>2</sup>	Težina (kg/100m)
Diameter	MBL	MBL	Weight
8	45,20	48,4	29,10
9	57,20	61,2	36,80
10	70,60	75,60	45,40
11	85,40	91,50	54,9
12	102,0	109,0	65,4
13	119,0	128,0	76,7
14	138,0	148,0	89,0
16	181,0	194,0	116,0
18	229,0	245,0	147,0
20	282,0	302,0	182,0
22	342,0	366,0	220,0
24	406,0	435,0	262,0
26	477,0	511,0	307,0
28	553,0	593,0	356,0
32	723,0	774,0	465,0
36	914,0	980,0	588,0
38	1020,0	1090,0	656,0
40	1130,0	1210,0	726,0

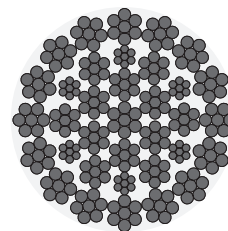

- EN 12385-4
- DIN 3072
- završna obrada: el. galvanizirano ili vruće cinčano
- čvrstoća žice: 1960 N/mm<sup>2</sup> ili 2160 N/mm<sup>2</sup>

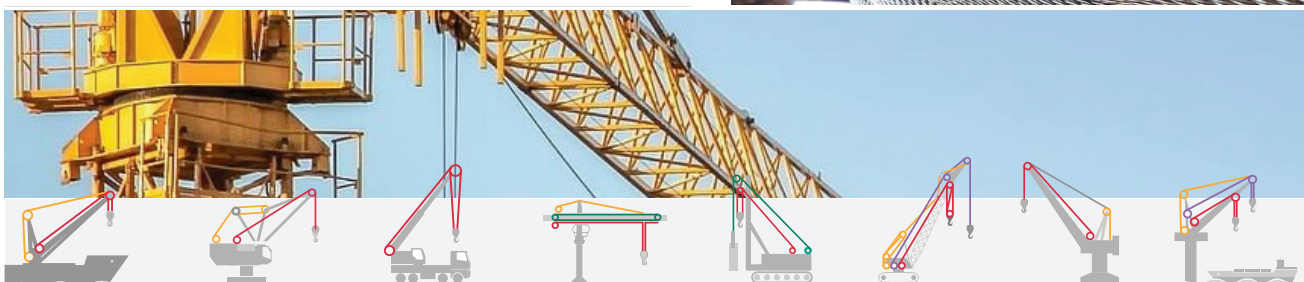

# 1. ČELIČNA UŽADI I LANCI

## Wire ropes and chains

### 1.3. Nerotirajuće uže

Čelično uže: 35W×K7+čelična jezgra KOMPAKTNO

Wire rope: 35Wx7+IWRC non-rotating, compacted

CE 2.1 2.2 3.1 BL

Promjer (mm)	Min. prekidna sila (kN) 2160 N/mm <sup>2</sup>	Težina (kg/100m)
Diameter	MBL	Weight
10	96	48
11	116	58
12	138	68
13	162	81
14	188	94
15	216	108
16	245	122
17	277	138
18	311	155
19	346	173
20	372	195
21	424	215
22	474	241
23	519	267
24	551	284
25	606	312
26	652	335
27	700	360
28	760	391
29	803	413
30	866	446
31	929	478
32	977	503
33	1032	536
34	1105	574
35	1166	606
36	1235	642
37	1296	674
38	1381	718
39	1449	753
40	1525	793
41	1954	828
42	1673	870
43	1756	913
44	1825	948
45	1912	993
46	2007	1040
47	2086	1080
48	2186	1140

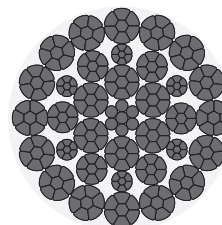

- EN 12385-4
- DIN 3072
- završna obrada: crno, el. galvanizirano ili vruće cinčano
- čvrstoća žice: 1960 N/mm<sup>2</sup> ili 2160 N/mm<sup>2</sup>

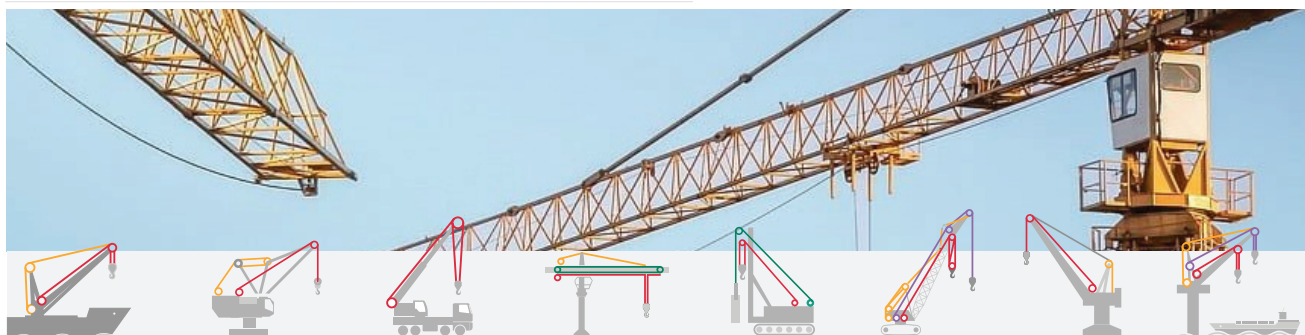

# 1. ČELIČNA UŽAD I LANCI

## Wire ropes and chains

### 1.3. Nerotirajuće uže

Čelično uže: 8 DURA PLUS CP čelična jezgra

Wire rope: 8 PLUS 8CP

CE 2.1 2.2 3.1 BL

Promjer (mm)	Min. prekidna sila (kN) 1960 N/mm <sup>2</sup>	Min. prekidna sila (kN) 2160 N/mm <sup>2</sup>	Težina (kg/100m)
Diameter	MBL	MBL	Weight
8	55,4	58,0	29,0
9	70,2	73,6	37,0
9,5	78,2	82,0	41,0
10	86,8	92,4	46,0
11	105,0	112,0	56,0
12	125,0	131,0	66,0
12,7	140,0	149,0	74,0
13	148,0	156,0	78,0
14	171,0	181,0	90,0
14,3	178,0	189,0	94,0
15	196,0	208,0	104,0
16	224,0	236,0	118,0
17	253,0	266,0	133,0
18	282,0	300,0	149,0
19	314,0	334,0	166,0
20	348,0	375,0	184,0
21	384,0	413,0	203,0
22	424,0	451,0	223,0
23	463,0	493,0	243,0
24	504,0	538,0	265,0
25	547,0	580,0	288,0
25,4	565,0	599,0	297,0
26	595,0	629,0	311,0
27	642,0	678,0	335,0
28	683,0	725,0	361,0
28,6	712,0	755,0	376,0
29	732,0	776,0	387,0
30	785,0	844,0	414,0
31	838,0	901,0	442,0
32	900,0	960,0	471,0
33	957,0	1021,0	501,0
34	1020,0	1084,0	532,0
35	1074,0	1140,0	560,0
36	1262,0	1205,0	596,0
38	1395,0	1349,0	664,0
40	1487,0	1480,0	736,0
41,3	1543,0	1578,0	784,0
42,0	1693,0	1640,0	811,0
44	1845,0	1800,0	891,0
46	2010,0	1967,0	973,0
48	2120,0	2140,0	1006,0
50	2180,0	2290,0	1150,0

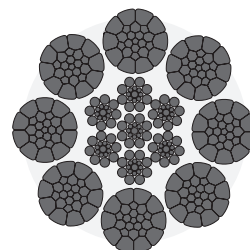

- EN 12385-4
- nerotirajuće, vrlo savitljivo uže, vrlo otporno na trošenje
- završna obrada: crno, el. galvanizirano ili vruće cinkano
- čvrstoća žice: 1960 N/mm<sup>2</sup> ili 2160 N/mm<sup>2</sup>



# 1. ČELIČNA UŽADI I LANCI

## Wire ropes and chains

### 1.3. Nerotirajuće uže

Čelično uže: 8 DURA PLUS 8P

Wire rope: 8 DURA PLUS 8P

CE 2.1 2.2 3.1 BL

Promjer (mm)	Min. prekidna sila (kN) 1770 N/mm <sup>2</sup>	Min. prekidna sila (kN) 1960 N/mm <sup>2</sup>	Težina (kg/100m)
Diameter	MBL	MBL	Weight
8	47,4	51,0	26
9	59,9	65,0	33
9,5	66,8	72,4	37
10	74,0	80,0	42
11	89,5	96,0	51
12	107,0	118,0	61
12,7	119,0	129,0	68
13	125,0	138,0	72
14	145,0	160,0	84
14,3	151,0	167,0	88
15	167,0	180,0	96
16	189,0	209,0	112
17	214,0	236,0	126
18	240,0	265,0	140
19	267,0	293,0	155
20	296,0	325,0	174
21	326,0	358,0	192
22	358,0	393,0	210
23	391,0	430,0	230
24	426,0	468,0	248
25	463,0	492,0	269
25,4	477,0	507,0	279
26	500,0	555,0	290
27	539,0	599,0	313
28	580,0	638,0	342
28,6	605,0	666,0	354
29	622,0	685,0	364
30	666,0	737,0	390
31	711,0	787,0	416
32	758,0	837,0	440
33	806,0	890,0	468
34	855,0	945,0	496
35	907,0	1000,0	533
36	959,0	1054,0	560
38	1069,0	1180,0	623
40	1184,0	1308,0	690
41,3	1262,0	1394,0	736
42,0	1305,0	1445,0	766
44	1433,0	1580,0	836
46	1566,0	1723,0	986
48	1705,0	1880,0	1010
50	1850,0	2040,0	1100

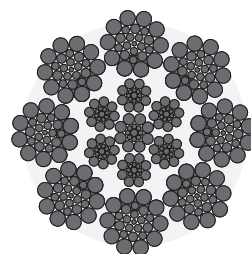

- EN 12385-4
- nerotirajuće, vrlo savitljivo uže
- završna obrada: crno, el. galvanizirano ili vruće cinčano
- čvrstoća žice: 1770 N/mm<sup>2</sup> ili 1960 N/mm<sup>2</sup>

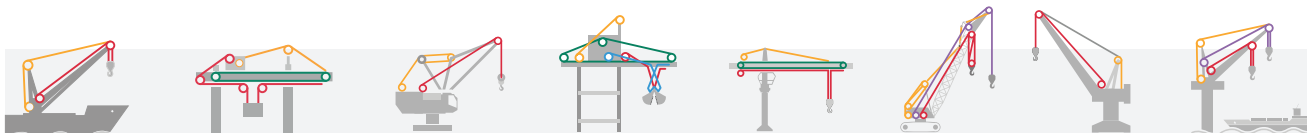

# 1. ČELIČNA UŽAD I LANCI

## Wire ropes and chains

### 1.4. Liftovsko uže

Čelično uže: 8×19S+vlaknasta jezgra

Wire rope: 8x19S+FC

CE 2.1 2.2 3.1 BL

Promjer (mm)	Min. prekidna sila (kN) 1370/1770 N/mm <sup>2</sup>	Min. prekidna sila (kN) 1570 N/mm <sup>2</sup>	Težina (kg/100m)
Diameter	MBL	MBL	Weight
6,5	22,0	22,2	17,0
8	31,7	33,2	23,0
9	40,1	42,0	29,0
10	49,5	51,8	35,0
11	59,5	62,7	43,0
12	71,3	74,6	51,7
13	83,7	87,6	60,0
14	97,0	102,0	70,0
16	127,0	133,0	91,0
18	160,0	168,0	116,0
19	179,0	187,0	130,0
20	198,0	207,0	144,0

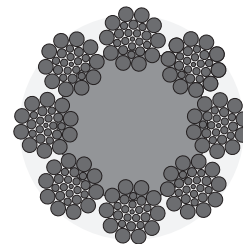

- EN 12385-5
- DIN 3063
- završna obrada: crno, el. galvanizirano ili vruće cinčano

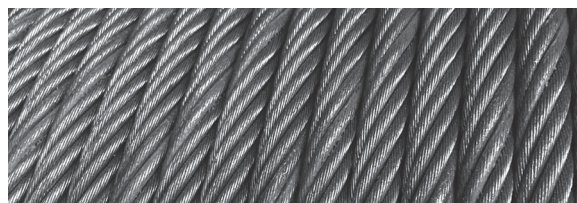

# 1. ČELIČNA UŽADI I LANCI

## Wire ropes and chains

### 1.5. Inox užje

#### Inox užje AISI 316: 7x7

Stainless steel rope: 7x7

Promjer (mm)	Min. prekidna sila (kN) 1570 N/mm <sup>2</sup>	Težina (kg/100m)
Diameter	MBL	Weight
1,0	0,56	0,38
1,5	1,27	0,86
2,0	2,25	1,54
2,5	3,52	2,40
3,0	5,1	3,50
4,0	9,0	6,10
5,0	14,10	9,6
6,0	20,3	13,80
8,0	36,1	24,60

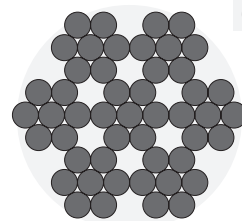

CE 2.1 2.2 3.1 BL

- EN 12385-4
- nehrđajući čelik AISI 316
- čvrstoća žice: 1570 N/mm<sup>2</sup>

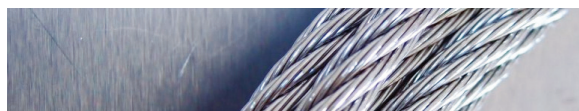

#### Inox užje AISI 316: 7x19

Stainless steel rope: 7x19

Promjer (mm)	Min. prekidna sila (kN) 1570 N/mm <sup>2</sup>	Težina (kg/100m)
Diameter	MBL	Weight
2,0	2,27	1,52
2,5	3,55	2,38
3,0	5,10	3,43
4,0	9,10	6,10
5,0	14,20	9,50
6,0	20,50	13,70
8,0	36,40	24,40
9,0	46,0	30,90
10,0	56,8	38,10
12,0	81,8	54,90

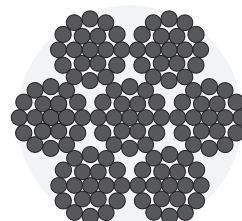

CE 2.1 2.2 3.1 BL

- EN 12385-4
- nehrđajući čelik AISI 316
- čvrstoća žice: 1570 N/mm<sup>2</sup>

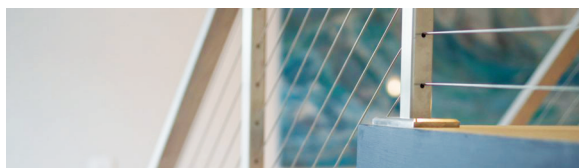

#### Inox užje AISI 316: 6x36WS

Wire rope: 6x36WS+IWRC

Promjer (mm)	Min. prekidna sila (kN) 1570 N/mm <sup>2</sup>	Težina (kg/100m)
Diameter	MBL	Weight
12	80,60	60,20
13	94,60	70,7
14	109,0	82,0
16	143,0	107,0
18	181,0	135,0
20	221,0	167,0
22	271,0	202,0
24	322,0	241,0
26	378,0	283,0

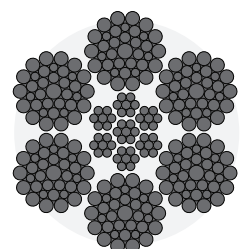

CE 2.1 2.2 3.1 BL

- EN 12385-4
- nehrđajući čelik AISI 316
- čvrstoća žice: 1570 N/mm<sup>2</sup>

# 1. ČELIČNA UŽAD I LANCI

# Wire ropes and chains

## 1.6. Ribarsko uže

Ribarsko uže: 6x7

**Wire rope: 6x7 (fishing purpose)**

CE 2.1 2.2 3.1 BL

Promjer (mm)	Min. prekidna sila (kN)	Težina (kg/100m)
Diameter	MBL	Weight
7	27,9	20
8	37,7	20
9	45,6	30
10	53,9	30
11	65,7	40
12	77	50
13	90,6	60
14	104,9	70
15	117,0	80

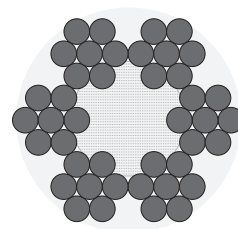

- tip: Bekaert
- čvrstoća žice: 1570 N/mm<sup>2</sup>

Ribarsko uže: 6x19

**Wire rope: 6x19 (fishing purpose)**

CE 2.1 2.2 3.1 BL

Promjer (mm)	Min. prekidna sila (kN)	Težina (kg/100m)
Diameter	MBL	Weight
14	102	70,9
16	146	90,9
18	185	116,8
20	228	144,2
22	276	175,1
24	328	205,4
26	385	241,4
27	416	261,8
28	447	279,2
30	513	315,6
32	584	370

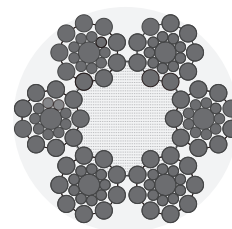

- tip: Bekaert
- čvrstoća žice: 1570 N/mm<sup>2</sup>



# 1. ČELIČNA UŽADI I LANCI

# Wire ropes and chains

## 1.7. Ribarsko uže

Ribarsko uže: 6x26

**Wire rope: 6x26WS (fishing purpose)**

CE 2.1 2.2 3.1 BL

Promjer (mm)	Min. prekidna sila (kN)	Težina (kg/100m)
Diameter	MBL	Weight
14	104	70,0
16	133	90,0
18	168	120,0
20	213	150,0
22	251	180,0

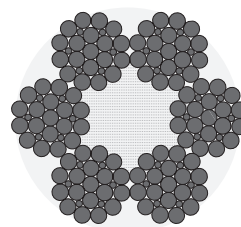

Ribarsko inox uže AISI 316: 7x7

**Stainless steel rope: 7x7 (fishing purpose)**

CE 2.1 2.2 3.1 BL

Promjer (mm)	Min. prekidna sila (kN)	Težina (kg/100m)
Diameter	MBL	Weight
7	27,6	22,0
8	36,1	25,0
9	45,7	30,0
10	56,4	38,0

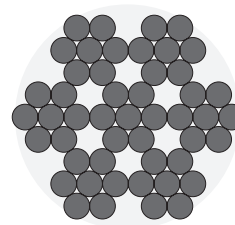

Vrtuljak sa ležajem oko-oko

**Thrust bearing swivel eye-eye**

2.1

Nosivost (t)	A (mm)	B (mm)	C (mm)	D (mm)	E (mm)	Težina (kg/kom)
WLL						Weight (kg/1pc)
1	174	128	12,5	49	21	1,4
2	223	173	19	68	22	3,5
3	278	210	26	79	29	6,4
5	290	222	26	89	31	7,9

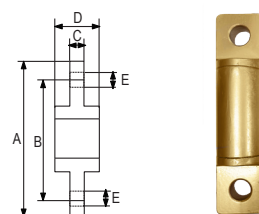

Sidro "Hall"

**Anchor Hall**

2.1

Nosivost (t)	A (mm)	B (mm)	C (mm)	D (mm)	E (mm)	F (mm)	G (mm)	H (mm)	Ø (mm)
WLL									
25	476	367	169	57	259	259	74	84	20
35	533	411	189	64	290	290	80	98	22
50	599	464	214	71	325	325	80	98	22
65	658	505	233	78	355	355	88	115	24
75	690	530	244	82	374	374	88	115	24
100	760	582	270	90	410	410	88	115	24
125	814	629	290	97	443	443	100	130	28
150	866	670	308	103	470	470	100	130	28
200	952	735	339	114	518	518	113	145	32
220	982	759	350	117	534	534	113	145	32
250	1019	784	361	121	552	552	125	160	36
300	1095	844	388	130	595	595	139	175	40

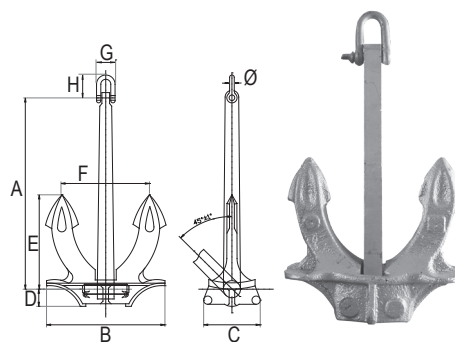

# 1. ČELIČNA UŽAD I LANCI

## Wire ropes and chains

### 1.7. Plastificirano čelično uže

#### Plastificirano čelično uže: 6×7+vlaknasta jezgra

Wire rope: 7x7 PVC coated rope

CE 2.1 2.2 3.1 BL

Promjer (mm)	Min. prekidna sila (kN) 1770 N/mm <sup>2</sup>	Težina (kg/100m)
Diameter	MBL	Weight
2/3	2.35	2.0
3/4	5.29	4.0
3/5	5.29	5.0
4/5	9.41	6.7
4/6	9.41	8.0
5/6	14.7	10.1
6/8	21.1	16.0
8/10	37.6	26.9

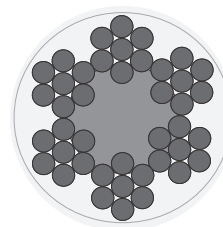

- EN 12385-4
- završna obrada: cinčano sa PVC plaštem
- čvrstoća žice: 1770 N/mm<sup>2</sup>

#### Plastificirano čelično uže: 6×19+vlaknasta jezgra

Wire rope: 6x19+fc PVC coated rope

CE 2.1 2.2 3.1 BL

Promjer (mm)	Min. prekidna sila (kN) 1770 N/mm <sup>2</sup>	Težina (kg/100m)
Diameter	MBL	Weight
3/4	4.9	3.9
3/5	4.9	4.9
4/5	8.7	6.5
4/6	8.7	7.8
5/6	13.6	9.9
6/8	19.6	15.6
8/10	34.8	26.2
10/12	54.4	39.6
12/14	78.3	55.7

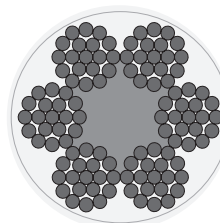

- EN 12385-4
- završna obrada: cinčano sa PVC plaštem
- čvrstoća žice: 1770 N/mm<sup>2</sup>



# 1. ČELIČNA UŽADI I LANCI

## Wire ropes and chains

### 1.8. Spiralno uže

#### Spiralno uže: 1×7

##### Spiral rope: 1x7

CE 2.1 2.2 3.1 BL

Promjer (mm)	Min. prekidna sila (kN) 1770 N/mm <sup>2</sup>	Težina (kg/100m)
Diameter	MBL	Weight
1,0	0,96	0,5
1,5	2,11	1,10
2,0	3,75	1,96
2,5	5,86	3,1
3,0	8,44	4,4
3,5	11,5	6,0
4,0	15,0	7,8
4,5	19,0	9,9
5,0	23,5	12,2
6,0	33,8	17,6

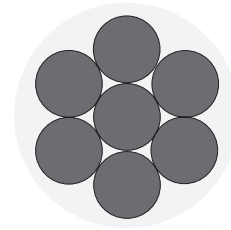

- EN 12385-10
- DIN 3052
- završna obrada: cinčano
- čvrstoća žice: 1770 N/mm<sup>2</sup>

#### Spiralno uže: 1×19

##### Spiral rope: 1x19

CE 2.1 2.2 3.1 BL

Promjer (mm)	Min. prekidna sila (kN) 1770 N/mm <sup>2</sup>	Težina (kg/100m)
Diameter	MBL	Weight
1,5	2,09	1,09
2,0	3,72	1,94
2,5	5,82	3,0
3,0	8,38	4,4
4,0	14,9	7,8
5,0	23,3	12,1
6,0	33,5	17,5
7,0	45,6	23,8
8,0	59,6	31,0

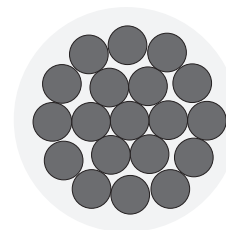

- EN 12385-10
- DIN 3053
- završna obrada: cinčano
- čvrstoća žice: 1770 N/mm<sup>2</sup>

#### Spiralno uže: 1×37

##### Spiral rope: 1x37

CE 2.1 2.2 3.1 BL

Promjer (mm)	Min. prekidna sila (kN) 1770 N/mm <sup>2</sup>	Težina (kg/100m)
Diameter	MBL	Weight
3,0	8,17	4,3
4,0	14,5	7,7
5,0	22,7	12,1
6,0	32,7	17,4
7,0	44,5	23,7
8,0	58,1	30,9
6,0	33,5	17,5
7,0	45,6	23,8
8,0	59,6	31,0

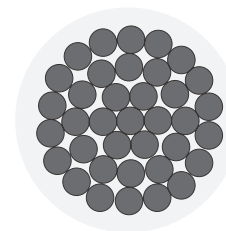

- EN 12385-10
- DIN 3054
- završna obrada: cinčano
- čvrstoća žice: 1770 N/mm<sup>2</sup>

# 1. ČELIČNA UŽAD I LANCI

## Wire ropes and chains

### 1.9. Uže za zip-line

#### Čelično uže za zip-line

##### Zipline wire rope

CE 2.1 2.2 3.1 BL

Promjer (mm) Diameter	Min. prekidna sila (kN) 1960 N/mm <sup>2</sup> MBL	Težina (kg/100 m) Weight
8,0	44,70	25,6
9,0	56,5	32,4
10,0	69,8	40,0
11,0	84,4	48,4
12,0	100,0	57,6
13,0	118,0	67,6
14,0	137,0	78,4
15,0	179,0	90,0
16,0	226,0	102,4

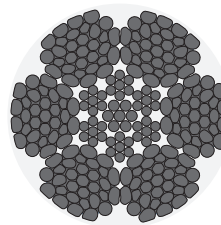

- završna obrada: vruće cinčano
- čvrstoća žice: 1960 N/mm<sup>2</sup>



# 1. ČELIČNA UŽADI I LANCI

## Wire ropes and chains

### 1.10. Čelična priveznica 1-kraka, 2-kraka, 3-kraka, 4-kraka

#### Tipovi čeličnih priveznica RX-lift

##### Wire rope slings types

- Čelične priveznice prema HRN EN 13414-1
- Faktor sigurnosti čelične priveznice: 5:1
- Elementi usklađeni sa nosivošću užadi

- Izrada različitih dužina i završetaka, strojno uprešano, upleteno ili zaliveno (Wirelock)

CE

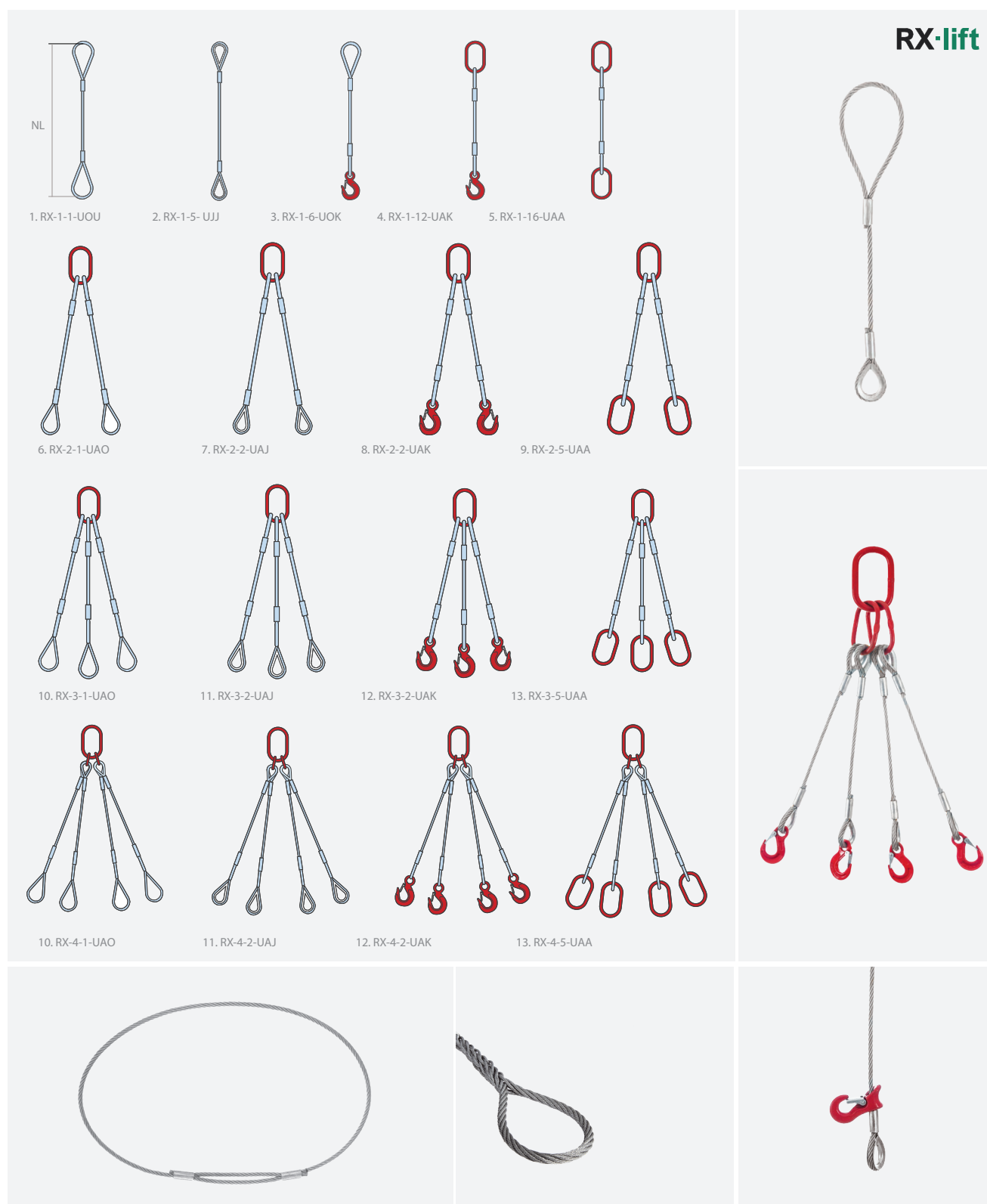

# 1. ČELIČNA UŽAD I LANCI

## Wire ropes and chains

### 1.10. Čelična priveznica 1-kraka, 2-kraka, 3-kraka, 4-kraka

Nosivosti čeličnih priveznica prema HRN EN 13414-1 RX-lift

WLLs of wire rope slings ac. to EN 13414-1

CE

- strojno uprešani krajevi
- čelično užje sa vlaknastom jezgrom, čvrstoće žice 1770 N/mm<sup>2</sup> (6x19+vj, 6x37+vj)
- faktor sigurnosti 5:1

Promjer užeta (mm)	Nosivost 1-krake priveznice (t) 0°-45°	Nosivost 2-krake priveznice (t) 0°-45°	Nosivost 3 i 4-krake priveznice (t) 0°-45°	Nosivost beskonačne priveznice (t) 0°
Diameter of wire rope	WLL of 1-leg sling	WLL of 2-leg sling	WLL of 3 and 4-leg sling	WLL of choke hitch
6	0,35	0,50	0,70	0,55
8	0,60	0,85	1,30	0,95
10	0,95	1,35	2,00	1,50
12	1,4	1,90	2,90	2,25
13	1,6	2,25	3,40	2,55
14	1,9	2,60	3,95	3,05
16	2,45	3,45	5,15	3,90
18	3,1	4,35	6,50	5,00
20	3,85	5,35	8,05	6,15
22	4,65	6,50	9,75	7,45
24	5,5	7,70	11,6	8,80
26	6,5	9,05	13,6	10,40
28	7,5	10,5	15,8	12,0
30	8,65	12,1	18,20	13,80
32	9,80	13,7	20,60	15,7
34	11,1	15,6	23,3	17,80
36	12,4	17,4	26,1	19,20
38	13,9	19,4	29,1	22,20
40	15,3	21,5	32,2	24,50
42	16,9	23,7	35,6	27,0
44	18,5	26,0	38,9	29,6
46	20,3	28,4	42,6	32,50
48	22,0	30,8	46,3	35,20
50	23,9	33,5	50,3	38,20
52	25,9	36,2	54,4	41,40
54	28,0	39,2	58,8	44,80
56	30,0	42,2	63,2	48,0
58	32,0	45,2	67,8	51,20
60	34,5	48,3	72,5	55,2
Faktor kraka:	1	1,4	2,1	1,6

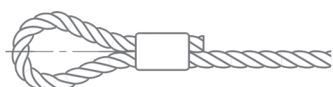

1. Omča uprešana alu. klemom

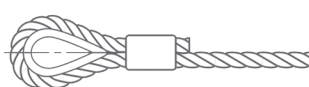

2. Jezgra uprešana alu. klemom

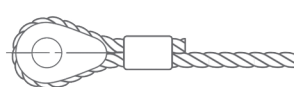

3. Pojačana jezgra uprešana alu. klemom

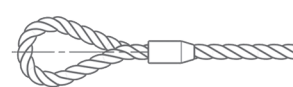

4. "Flemish eye" - upletena omča uprešana čeličnom klemom



5. Čelični čep uprešan na užje



6. Završetak sa navojm uprešan na užje



7. Završetak sa vilicom uprešan na užje

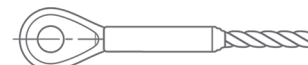

8. Završetak sa okom uprešan na užje

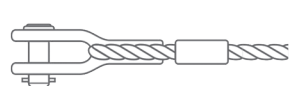

9. Završetak s vilicom osiguran klemom

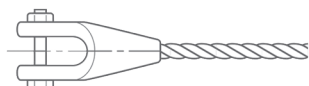

10. Otvoreni užni zatvarač

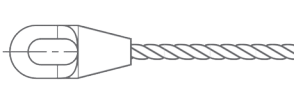

11. Zatvoreni užni zatvarač



12. Ručno upletena omča, ili jezgra

# 1. ČELIČNA UŽADI I LANCI

## Wire ropes and chains

### 1.11. Visokootporni lanac za dizanje

**RX-lift**

Lanac G80 EN 818-2 RX-lift

Chain acc. to EN 818-2 G80

2.1 2.2 CE BL

Promjer a (mm)	Nosivost (t)	Min. prekidna sila (t)	b (mm)	c (mm)	Broj karika / 1m	Težina (kg/m)
Diameter	WLL	MBL			Links per m	Weight
6	1,12	4,48	18	22	55,5	0,78
7	1,5	6,0	21	26	47,6	1,14
8	2,0	8,0	24	30	41,6	1,5
10	3,15	12,6	30	36	33,3	2,27
13	5,3	21,2	39	47	25,6	3,74
16	8	32,0	48	58	20,8	5,54
20	12,5	50,0	60	72	16,6	8,94
22	15,0	60,0	66	79	15,1	11,57
26	21,2	86,4	78	93	12,82	15,26
32	31,5	126	96	112	10,42	22,6

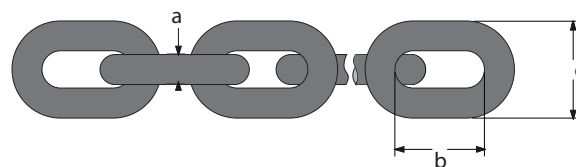

- lanac prema standardu: EN 818-2 (DIN5687)
- visokokvalitetni lanac G80 za prijenos i osiguranje tereta
- specijaliziran za dinamička i statička opterećenja
- kalibrirane karike lanca, dopuštenja odstupanja u dimenzijama samo +/-3%
- faktor sigurnosti: 4:1
- temperatura rada za: -40°C do + 200°C (WLL 100%)
- oznake dimenzije i kvalitete na karikama
- dostupni elementi za lanac G80
- završna obrada: prirodna boja, ili lakirani



Lanac G100

Chain according to EN 818-2, grade G100

**GUNNEBO**

2.1 2.2 CE BL

Promjer a (mm)	Nosivost (t)	Prekidna sila (kN)	b (mm)	c (mm)	Težina (kg/m)
Diameter	WLL	MBL			Weight
6	1,5	58,9	18	20,5	0,87
7	1,95	77	21	24,0	1,14
8	2,5	102	24	27,0	1,45
10	4,0	158	30	34,0	2,25
13	6,8	268	39	43,7	3,76
16	10,0	402	48	53,9	5,64
20	16,0	630	60	67,0	9,4
22	20,0	785	66	73,0	11,9
26	27,0	1062	78	87,0	16,4
32	40,0	1610	96	105,6	25,8

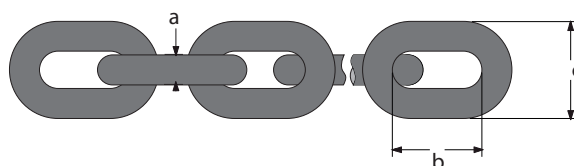

- lanac prema standardu: EN 818-2
- visokokvalitetni lanac za prijenos i vuču tereta
- 25% jači od lanca G80
- specijaliziran za dinamička i statička opterećenja
- kalibrirane karike lanca
- faktor sigurnosti: 4:1
- temperatura rada za: -40°C do + 200°C (WLL 100%)
- dostupni elementi za lanac G100
- završna obrada: plastificirani plavi



# 1. ČELIČNA UŽAD I LANCI

## Wire ropes and chains

### 1.11. Visokootporni lanac za dizanje

Lanac G80 za ručne dizalice EN 818-7 RX-lift

Manual hoists chain G80 acc. to EN 818-7

2.1 2.2 CE BL

Promjer a (mm)	b (mm)	c (mm)	Prekidna sila (kN)	Težina (kg/m)
Diameter			Breaking load	Weight
4	12	13	20.2	0.35
5	15	17	31.6	0.56
6	18	22.2	45.4	0.80
7	21	25.9	61.6	1.08
8	24	29.6	80.6	1.43
10	30	37.0	126.0	2.22

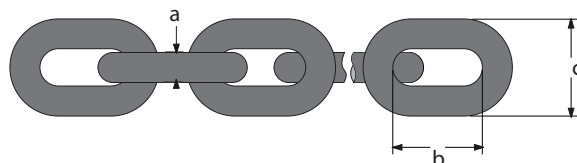

- lanac prema standardu: EN 818-7 (DIN 5684)
- lanac G80 je visokokvalitetni lanac za lančane ručne dizalice
- specijaliziran za dinamička i statička opterećenja
- kalibrirane karike lanca
- faktor sigurnosti: 4.0
- završna obrada: cinčani



Lanac kvadratnih karika G80 RX-lift

Square link chain G80

2.1 2.2 CE BL

Promjer a (mm)	b (mm)	c (mm)	Prekidna sila (kN)	Težina (kg/m)
Diameter			Breaking load	Weight
7	24	10	80	1,4
8	28	11	90	1,5
10	35	14	126	2,2

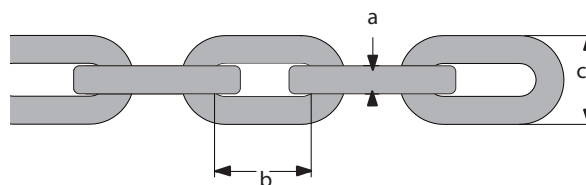

- visokokvalitetni lanac za prijenos i vuču tereta
- prikladan u šumarstvu
- specijaliziran za dinamička i statička opterećenja
- kalibrirane karike lanca
- faktor sigurnosti: 4.0
- dostupni elementi za lanac G80
- završna obrada: prirodna boja, ili lakirani



# 1. ČELIČNA UŽADI I LANCI

## Wire ropes and chains

### 1.12. Lanci opće namjene

#### Lanac komercijalni, standardna karika

Chain for commercial use medium link

2.1 2.2 BL

Promjer a (mm)	b (mm)	c (mm)	Prekidna sila (kg)	Težina (kg/m)
Diameter			Breaking load	Weight
3	20	12	400	0,11
4	23	16	650	0,18
5	25	18	800	0,25
6	26	19	1100	0,35
7	26	23	1500	0,50
8	32	29	2400	0,78
10	35	35	3400	1,14
11	38	38	4600	1,58
13	50	45.5	6000	2,00

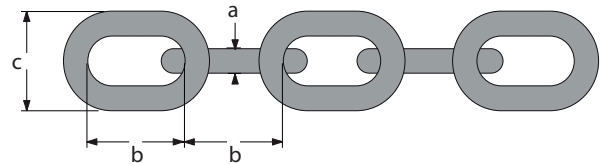

- komercijalni lanac za privez
- materijal: čelik
- završna obrada: cinčani, crni ili polirani

#### Lanac DIN 5685A

Chain for commercial use acc. to DIN 5685 type A

2.1 2.2 BL

Promjer a (mm)	b (mm)	c (mm)	Prekidna sila (kN)	Težina (kg/m)
Diameter			Breaking load	Weight
2,0	12	8	1,25	0,07
2,5	14	10	2,0	0,11
3,0	16	12	2,8	0,16
3,5	18	14	3,85	0,22
4,0	19	16	5,0	0,30
4,5	20	18	6,3	0,39
5,0	21	20	7,7	0,50
6,0	24	24	11,5	0,73
7,0	28	28	21,3	1,00
8,0	32	32	20,0	1,30
10,0	40	40	31,0	2,05
12,0	48	48	45,0	2,90
13,0	52	52	53,0	3,45

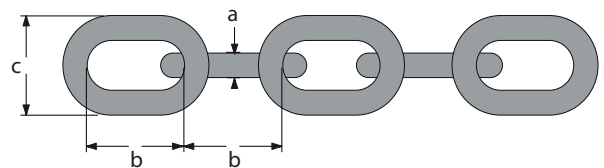

- lanac prema standardu: DIN 5685
- komercijalni lanac za privez
- materijal: čelik ili AISI 316
- završna obrada: cinčani, crni ili polirani



# 1. ČELIČNA UŽAD I LANCI

## Wire ropes and chains

### 1.12. Lanci opće namjene

#### Lanac DIN 763 G30

Chain for commercial use acc. to DIN 763

2.1 2.2 BL

Promjer a (mm)	b (mm)	c (mm)	Prekidna sila (kN)	Težina (kg/m)
Diameter			Breaking load	Weight
2	22	8	1,25	0,06
3	26	12	3,25	0,15
4	32	16	6,0	0,27
5	35	20	10,0	0,43
6	42	24	14,0	0,63
7	49	28	18,0	0,86
8	52	32	25,0	1,10
9	59	36	32,0	1,41
10	65	40	40,0	1,75
11	72	44	47,5	2,11
12	78	48	56,5	2,55
13	82	52	63,0	2,95
16	100	64	100,0	4,45
18	113	70	127,0	5,65
20	120	75	160,0	7,00
22	127	82	190,0	8,55
25	140	85	245,0	10,9
28	152	96	300,0	13,9
32	171	108	400,0	18,2
36	216	120	610	22,5

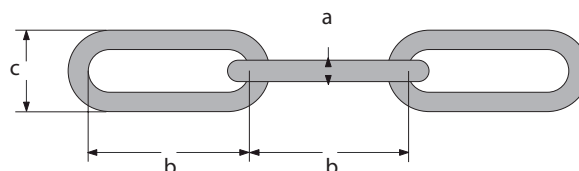

- lanac prema standardu: DIN 763
- komercijalni lanac za privez i sidrenje
- materijal: čelik ili AISI 316
- završna obrada: cinčani, crni ili polirani



#### Lanac DIN 766 G30

Chain for commercial use acc. to DIN 766

2.1 2.2 BL

Promjer a (mm)	b (mm)	c (mm)	Prekidna sila (kN)	Težina (kg/m)
Diameter			Breaking load	Weight
2	12	7,5	-	0,07
3	16	11	-	0,16
4	16	13	7,0	0,32
5	18,5	17	12,5	0,50
6	18,5	20,2	16,5	0,80
7	22	23,8	25,0	1,10
8	24	27,2	32,0	1,40
9	27	30,6	40,0	1,80
10	28	34	50,0	2,20
11	31	37,4	60,0	2,70
12	36	40,8	70,0	3,10
13	36	44,2	80,0	3,80
14	41	47,6	92,0	4,40
16	45	54,4	125,0	5,70
18	50	61,2	160,0	7,30
19	53	64,6	180,0	7,97
20	56	68,0	200,0	9,00
22	62	75,0	250,0	11,0
26	73	88,4	320,0	15,0
28	78	95,2	370,0	19,5
30	84	102	450,0	23,0

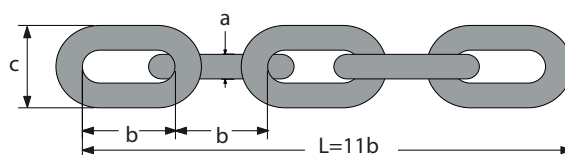

- lanac prema standardu: DIN 766
- komercijalni lanac za privez, sidrenje i brodska vitla
- materijal: čelik ili AISI 316
- završna obrada: cinčani, crni ili polirani



# 1. ČELIČNA UŽADI I LANCI

## Wire ropes and chains

### 1.12. Lanci opće namjene

#### Lanac DIN 764 G30

Chain for commercial use acc. to DIN 764

2.1 2.2 BL

Promjer a (mm)	b (mm)	c (mm)	Prekidna sila (kN)	Težina (kg/m)
Diameter			Breaking load	Weight
4	16	14.00	7.0	0,31
5	18	18.20	11.8	0,51
6	21	21.50	16.5	0,74
8	28	29.00	32.0	1,31
10	35	36.00	50.0	2,0
12	42	41.00	70.0	2,98
13	45	47.00	80.0	3,50
14	49	48.00	92.0	4,06
16	56	58.00	125.0	5,20
18	63	65.00	160.0	6,50
20	70	72.00	200	8,20
23	80	83.00	250.0	11,0
26	91	94.00	320.0	14,0
28	98	100.00	360.0	16,5
30	105	108.00	415.0	19,0
32	115	119.00	500.0	22,5

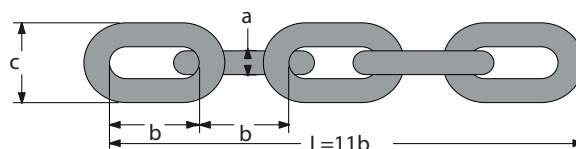

- lanac prema standardu: DIN 764
- komercijalni lanac za privez i sidrenje
- materijal: čelik ili AISI 316
- završna obrada: cinčani, crni ili polirani



#### Lanac za rudnike DIN 22252

High Strength Mining Chain

2.1 2.2 BL

d×p (mm)	p (mm)	Tolerancija p (mm)	a (mm)	b (mm)	5xp (mm)	Tolerancija 5xp (mm)	Težina (kg/m)	Ispitna sila Razred B (kN)	Ispitna sila Razred C (kN)	Ispitna sila Razred D (kN)
		Tolerance p				Tolerance 5xp		Test Load (Grade B)	Test Load (Grade C)	Test Load (Grade D)
10×40	40	±0.5	12	34	200	±0.7	1.9	85	100	130
14×50	50	±0.5	17	48	250	±0.88	4.0	150	200	250
18×64	64	±0.6	21	60	320	±1.22	6.6	260	330	410
22×86	86	±0.9	26	74	430	±1.51	9.5	380	490	610
26×92	92	±0.9	30	86	460	±1.60	13.7	540	680	850
30×108	108	±1.0	34	98	540	±1.89	18.0	710	900	1130
34×126	126	±1.2	38	109	630	±2.21	22.7	900	1160	1450

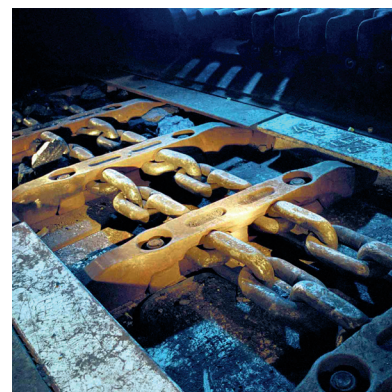
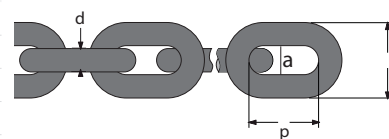

# 1. ČELIČNA UŽAD I LANCI

# Wire ropes and chains

## 1.13. Lančane priveznice

**RX-lift**

Lančane priveznice kvalitete G80 i G100 prema EN 818-4 RX-lift

Chain slings Grade 8 or 10 acc. to EN 818-4

- Lančane priveznice lanca G80 i G100
- Faktor sigurnosti čelične priveznice: 4:1
- Elementi usklađeni sa nosivošću lanaca
- Različite kombinacije elemenata

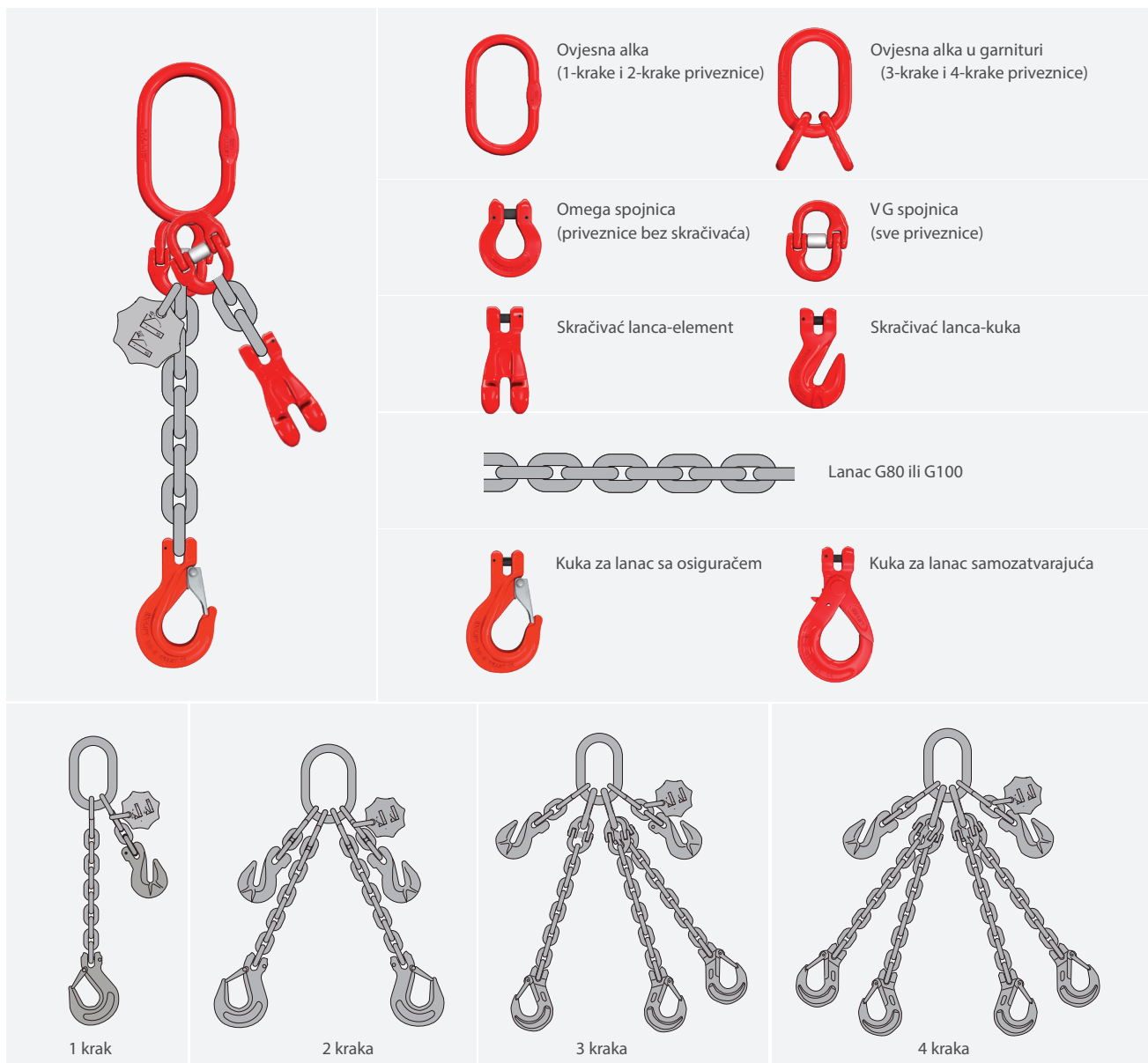

# 1. ČELIČNA UŽADI I LANCI

## Wire ropes and chains

### 1.13. Lančane priveznice

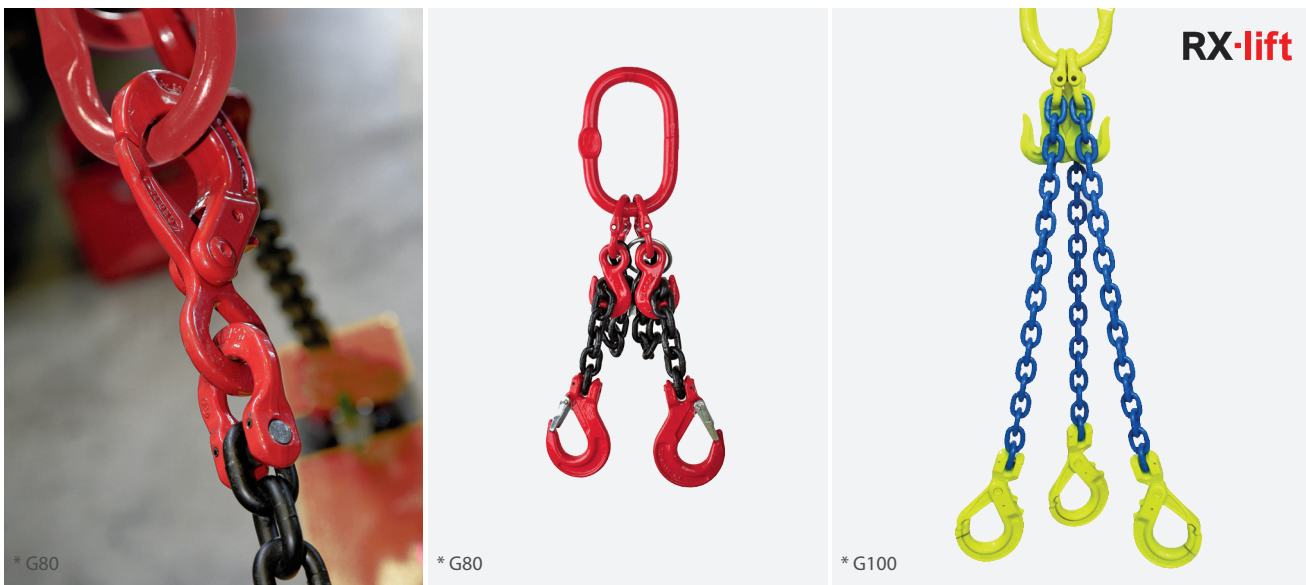

#### Lančane priveznice kvalitete G80 prema EN 818-4 RX-lift

G80 chain slings acc. to EN 818-4

Lanac G80 (mm)	Nosivost 1-krake priv. 0-90° (t)	Nosivost 2-krake priv. 0-45° (faktor 1,4) (t)	Nosivost 2-krake priv. 45-60° (faktor 1,0) (t)	Nosivost 3-krake i 4-krake priv. 0-45° (faktor 2,1) (t)	Nosivost 3-krake i 4-krake priv. 45-60° (faktor 1,5) (t)	Nosivost beskonačne priv. (faktor 1,6) (t)
Chain diameter	WLL 1-leg sling	WLL 2-leg sling	WLL 3-leg sling	WLL 1-leg sling	WLL 4-leg sling	WLL of endless sling
6	1,12	1,6	1,12	2,36	1,7	1,8
7	1,5	2,12	1,5	3,15	2,24	2,5
8	2,0	2,8	2,0	4,25	3,0	3,15
10	3,15	4,25	3,15	6,7	4,75	5,0
13	5,3	7,5	5,3	11,2	8,0	8,5
16	8,0	11,2	8,0	17,0	11,8	12,5
18	10,0	14,0	10,0	21,0	15,0	16,0
20	12,5	17,0	12,5	26,5	19,0	20,0
22	15,0	21,2	15,0	31,50	22,4	23,6
26	21,2	30,0	21,2	45,0	31,5	33,5
32	31,5	45,0	31,5	67,0	47,50	50

#### Lančane priveznice kvalitete G100 prema EN 818-4 RX-lift

G100 chain slings acc. to EN 818-4

Lanac G100 (mm)	Nosivost 1-krake priv. 0-90° (t)	Nosivost 2-krake priv. 0-45° (faktor 1,4) (t)	Nosivost 2-krake priv. 45-60° (faktor 1,0) (t)	Nosivost 3-krake i 4-krake priv. 0-45° (faktor 2,1) (t)	Nosivost 3-krake i 4-krake priv. 45-60° (faktor 1,5) (t)
Chain diameter	WLL 1-leg sling	WLL 2-leg sling	WLL 3-leg sling	WLL 1-leg sling	WLL 4-leg sling
6	1,5	2,1	1,5	3,10	2,2
7	1,95	2,7	1,95	4,0	2,9
8	2,5	3,5	2,5	5,2	3,7
10	4,0	5,6	4,0	8,4	6,0
13	6,8	9,5	6,8	14,2	10,2
16	10,0	14,1	10,0	21,0	15,0
20	16,0	22,5	16,0	33,6	24,0
22	20,0	28,2	20,0	42,0	30,0
26	27,0	38,0	27,0	56,7	40,50
32	40,0	56,4	40,0	84,0	60,0

# 1. ČELIČNA UŽAD I LANCI

## Wire ropes and chains

### 1.13. Lančane priveznice

#### Lanac Tycan za dizanje tereta

Tycan chain for lifting purposes

2.1 2.2 MTCb CE

Veličina karike (mm)	Nosivost (kg)	a (mm)	b (mm)	c (mm)	Karika po 1m	Broj slojeva	Težina (kg/m)
WLL					Links per metre	Layers	Weight
11 x 15	2.6	15	11	100	10	6	0.32
11 x 20	4	20	11	100	10	6	0.47
15 x 25	5	25	15	100	10	8	0.58
13 x 30	6.8	30	13	125	8	7	0.75

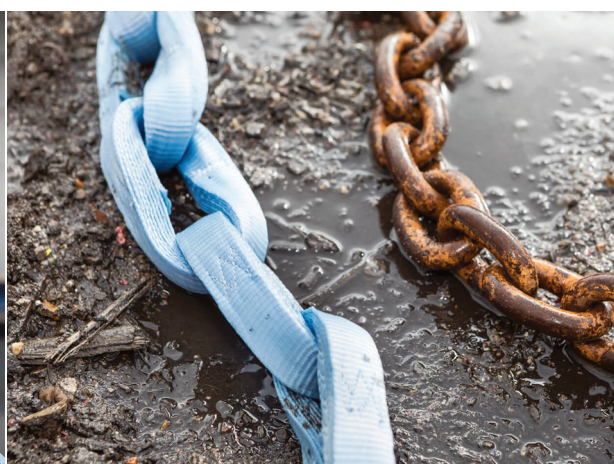
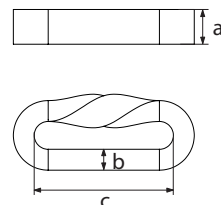

#### Lančani komplet sa zatezačem-račnom Tycan

Lashing Tycan chain

Veličina karike (mm)	Lashing kapacitet	Br. karika na 1m	Min. prekidna sila (t)	Elongacija pri min. prekidnoj sili	Težina (kg/m)
Link size	Lashing capacity	Links per meter	MBL	Elongation at MBL	Weight per m
15x25	10	10	20	5	0,58



CE

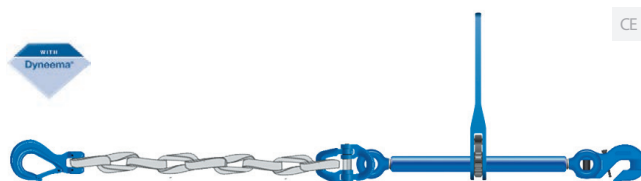

# 1. ČELIČNA UŽADI I LANCI

## Wire ropes and chains

### 1.13. Lančane priveznice

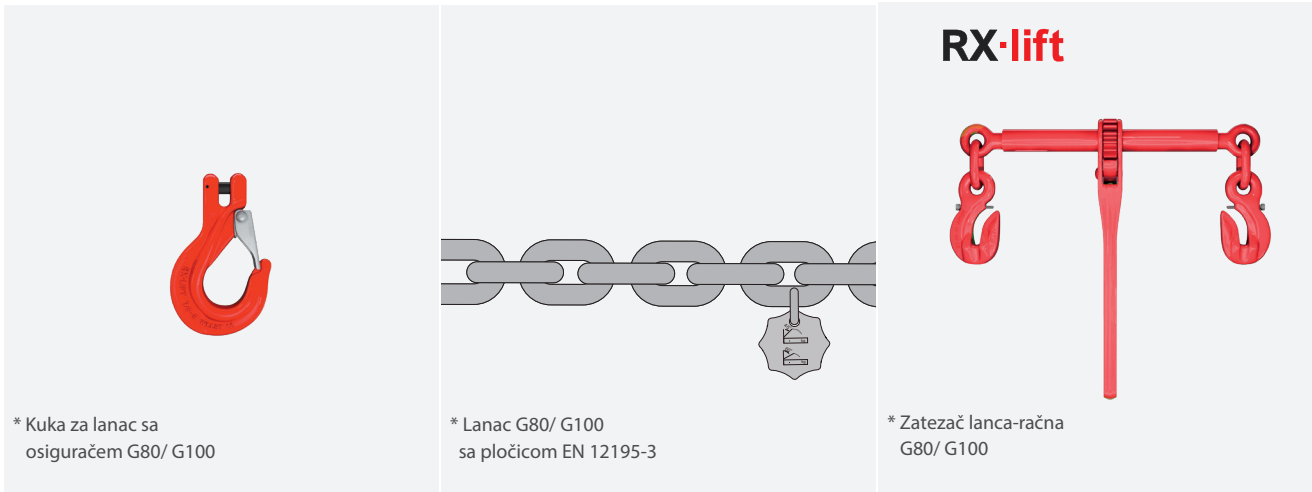

#### Lančani komplet sa zatezačem-račnom EN 12195-3 RX-lift

Lashing chain G80 with ratchet load binder EN 12195-3

CE

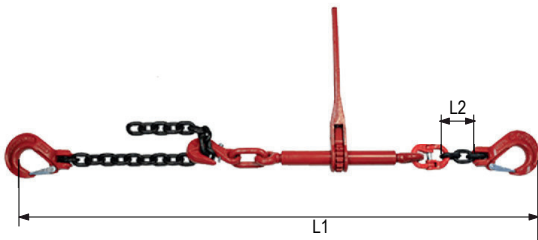

- duljina lanca i elementi proizvoljni, prema standardu

Promjer lanca kvalitete G80 (mm)	Sila zatezanja - LC (daN)	Standardna sila zatezanja - STF (daN)
Chain diameter	LC	STF
6	2000	500
8	4000	1000
10	6300	1575
13	10000	1500
16	16000	2400

Promjer lanca kvalitete G100 (mm)	Sila zatezanja - LC (daN)	Standardna sila zatezanja - STF (daN)
Chain diameter	LC	STF
8	5000	1250
10	8000	2000
13	13400	2000



# 1. ČELIČNA UŽAD I LANCI

## Wire ropes and chains

### 1.14. Čelična užad i lanci za šumarstvo

Čelično uže: 6×26WS+ čelična jezgra, dvostruko prešano

Wire rope: 6x26WS+ IWRC, super swaged

CE 2.1 2.2 3.1 BL

Promjer (mm)	Min. prekidna sila (kN) 1960 N/mm <sup>2</sup>	Težina (kg/100 m)
Diameter	MBL	Weight
9	79,0	47,0
10	97,0	56,9
11	121,0	69,0
12	139,0	81,0
13	163,0	96,0
14	189,0	111,0
15	217,0	127,0
16	248,0	145,0
18	310,0	184,0

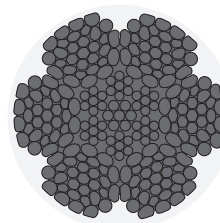

- EN 12385-4
- DIN 3064
- završna obrada: crno/ mašćeno
- čvrstoća žice: 1960 N/mm<sup>2</sup> ili 2160 N/mm<sup>2</sup>



Čelično uže: 6×36WS+ čelična jezgra

Wire rope: 6x36WS+ IWRC, 6x31WS +IWRC, 6x41WS +IWRC

CE 2.1 2.2 3.1 BL

Promjer (mm)	Min. prekidna sila (kN) 1960 N/mm <sup>2</sup>	Težina (kg/100 m)
Diameter	MBL	Weight
8	44,70	26,2
9	56,5	33,1
10	69,8	40,9
11	84,4	49,5
12	100,0	58,9
13	118,0	69,10
14	137,0	80,20
16	179,0	105,0
18	226,0	133,0

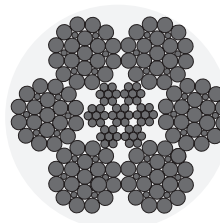

- EN 12385-4
- DIN 3064
- završna obrada: crno/ mašćeno
- čvrstoća žice: 1960 N/mm<sup>2</sup> ili 2160 N/mm<sup>2</sup>



# 1. ČELIČNA UŽADI I LANCI

## Wire ropes and chains

### 1.14. Čelična užad i lanci za šumarstvo

Čelično uže: 6x26WS+ čelična jezgra

Wire rope: 6x26WS+ IWRC

CE 2.1 2.2 3.1 BL

Promjer (mm)	Min. prekidna sila (kN) 1770 N/mm <sup>2</sup>	Min. prekidna sila (kN) 1960 N/mm <sup>2</sup>	Težina (kg/100 m)
Diameter	MBL	MBL	Weight
10	63,0	69,8	40,0
12	90,7	100,0	57,60
14	124,0	137,0	78,4
16	161,0	179,0	102,0

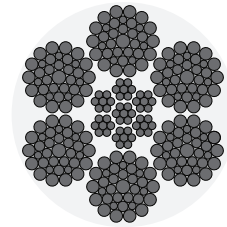

- EN 12385-4
- DIN 3064
- završna obrada: crno, el. galvanizirano ili vruće cinčano
- čvrstoća žice: 1770 N/mm<sup>2</sup> ili 1960 N/mm<sup>2</sup>

Čelično uže: 6x37+ vlaknasta jezgra

Wire rope: 6x37+ FC

CE 2.1 2.2 3.1 BL

Promjer (mm)	Min. prekidna sila (kN) 1770 N/mm <sup>2</sup>	Težina (kg/100 m)
Diameter	MBL	Weight
8	33.4	26.1
9	42.3	28.0
10	52.2	34.6
12	75.2	49.8
14	102.0	67.8
16	134.0	88.6

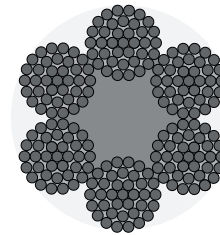

- EN 12385-4
- DIN 3066, opća namjena
- završna obrada: crno ili cinčano
- čvrstoća žice: 1770 N/mm<sup>2</sup>
- uže opće namjene, najmanje čvrstoće, ali najfleksibilnije

Šumarske omče RX-lift

Forest wire rope slings

2.1

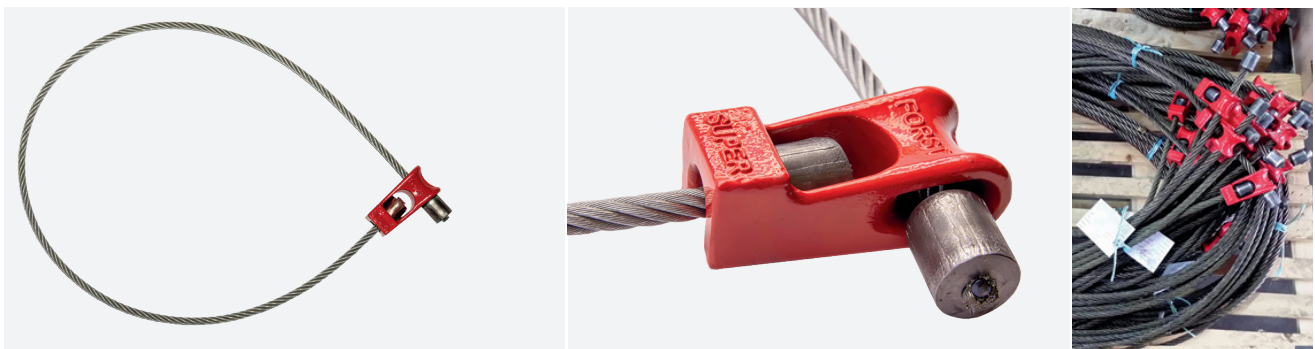

Promjer užeta (mm)	Min. prekidna sila užeta 6x36ws+čj 1960N/mm <sup>2</sup> (kN)
Diameter of rope	MBL of 6X36IWRC
10	62
12	90
14	124

- čelično uže: 6x36+čj, 6x26+čj, 6x37+vj
- čepovi na krajevima
- klizači – čokeri različitih vrsta
- duljina omče: obično od 1.0 m do 3-4.0m

# 1. ČELIČNA UŽAD I LANCI

## Wire ropes and chains

### 1.14. Čelična užad i lanci za šumarstvo

#### Šumarski lanac + kuka G80 RX-lift

Forest towing chain with hook G80

2.1

Promjer karike (mm)	Min. prekidna sila (kN)	Težina (kg/m)
Diameter	MBL	Weight
7	61.6	1,14
8	80.6	1,5
10	126.0	2,27



#### Šumarski lanac + kuka G80 kvadratni RX-lift

Forest towing chain with hook G80 square link chain

2.1

Promjer karike (mm)	Min. prekidna sila (kN)	Težina (kg/m)
Diameter	MBL	Weight
7	61,6	1,4
8	80,6	1,5



#### Šumarski lanac + kuka G100 RX-lift

Forest towing chain with hook G100

2.1

Promjer karike (mm)	Min. prekidna sila (kN)	Težina (kg/m)
Diameter	MBL	Weight
7	77	1,14
8	102	1,45
10	158	2,25



#### Šumarski lanac + kuka G100 kvadratni RX-lift

Forest towing chain with hook G100 square link chain

2.1

Promjer karike (mm)	Min. prekidna sila (kN)	Težina (kg/m)
Diameter	MBL	Weight
7	80	1,16
8	120	1,8



#### Kuka za šumarski lanac G80 RX102

Clevis forest hook for logging G80

2.1 2.2 CE BL

Promjer lanca (mm)	Nosivost (t)	Prekidna sila (t)	B (mm)	A (mm)	E (mm)	H (mm)	M (mm)	N (mm)	L (mm)	Težina (kg/kom)
Chain dia.	WLL/T	BL								Weight
7/8-8	2	8	35	9.5	10.5	18	72.7	22	95.5	0.413
10-8	3.15	12.6	44	13	13	22	97	33.5	137	0.92
13-8	5.3	21.2	53	16	16	30	119	40	165	1.75

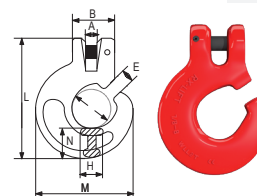

- EN 1677-1
- namjena : šumarstvo, nije za dizanje tereta

#### Kuka za šumarski lanac G100 RX1021

Clevis forest hook for logging G100

2.1 2.2 CE BL

Promjer lanca (mm)	Nosivost (t)	Prekidna sila (t)	A (mm)	M (mm)	N (mm)	E (mm)	L (mm)	Težina (kg/kom)
Chain dia.	WLL	BL						Weight
8-10	2.5	10	9.5	35	24	9.8	95.5	0.39
13-10	6.7	26.8	16	59	49.5	16	162	1.62

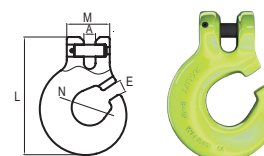

- EN 1677-1
- namjena : šumarstvo, nije za dizanje tereta

# 1. ČELIČNA UŽAD I LANCI

## Wire ropes and chains

### 1.14. Čelična užad i lanci za šumarstvo

Klizači - čokeri G80 RX-lift

Choker hooks G80 RX-lift

21



1. Klizač "čoker"  
kosi glavni veliki



2. Klizač "čoker" kosi  
glavni bočni



3. Klizač "čoker" kosi  
glavni mali



4. Klizač "čoker"  
Superforst



5. Klizač lanca  
za čel. uže



6. Klizač lanca za  
čel. uže - okretni



7. Klizač lanca za  
č. uže sa lagerom



8. Klizač lanca  
za č. uže - kuka



9. Ovjesna alka  
za šumarski lanac



10. Završetak za  
šumarsko uže okretni



11. Završetak za  
šumarsko uže fiksni

**RX-lift**

# 1. ČELIČNA UŽAD I LANCI

## Wire ropes and chains

### 1.14. Čelična užad i lanci za šumarstvo

Lanci za traktorske kotače - različiti tipovi RX-lift

Traction Chains for Challenging Forestry Conditions

21

Tipovi lanaca za šumarstvo:

- klasični kopitar
- kopitar multiring
- mrežasti bodljikavac
- bodljikavac sa pločicama
- lanac sa pločicama

**RX-lift**

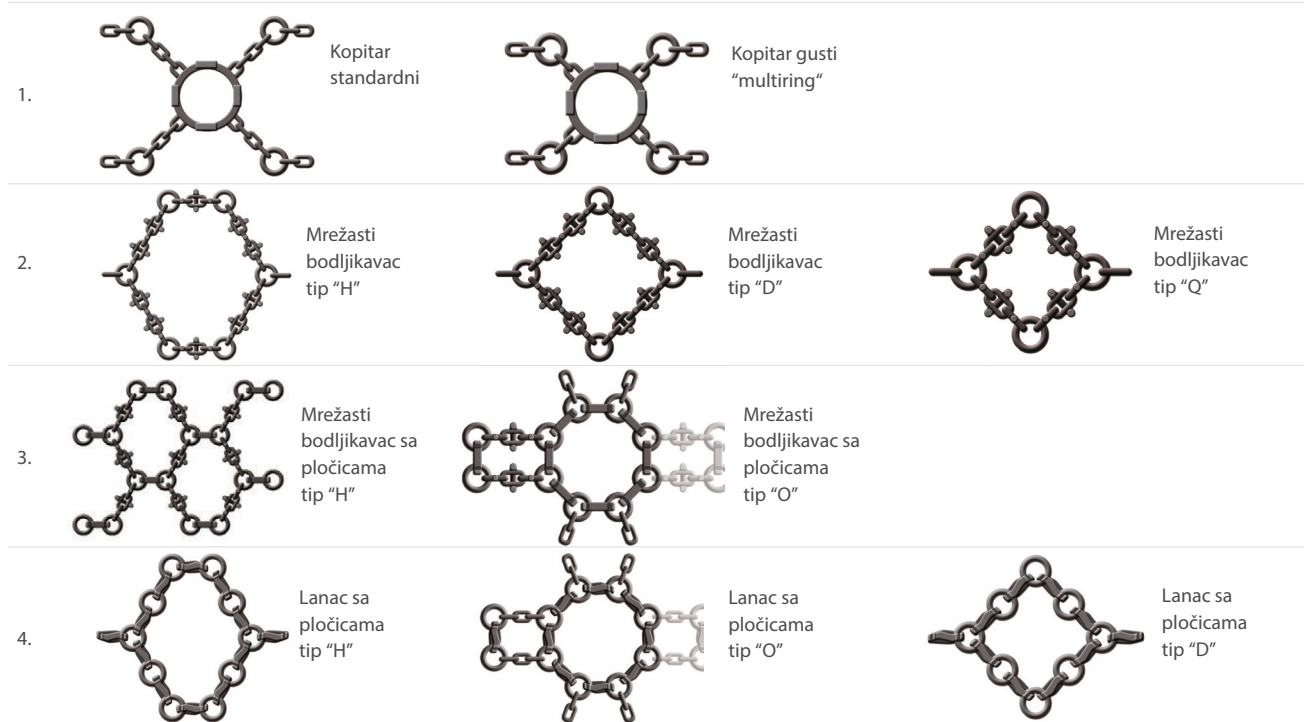

# 1. ČELIČNA UŽAD I LANCI

## Wire ropes and chains

### 1.14. Čelična užad i lanci za šumarstvo

Veličine kotača	Veličine kotača	Veličine kotača	Veličine kotača
Wheel dimensions	Wheel dimensions	Wheel dimensions	Wheel dimensions
14,5x20	18,4 x 26	540/65 - 34	18,4 x 30
400/70-20	23,1 x 26	600/65 - 34	420/85 - 30
500/60-22,5	28,1 x 26	700/55 - 34	480/70 - 30
550/45-22,5	620/75 - 26	700/70 - 34	520/75 - 30
600/40-22,5	500/60 - 26,5	710/55 - 34	540/65 - 30
600/50 - 22,5	600/55 - 26,5	710/70 - 34	540/70 - 30
600/55 - 22,5	600/65 - 26,5	750/65 - 34	600/60 - 30,5
650/45 - 22,5	650/60 - 26,5	480/70 - 38	620/55 - 30,5
700/40 - 22,5	650/65 - 26,5	600/65 - 38	700/50 - 30,5
700/45 - 22,5	700/50 - 26,5	600/70 - 38	710/50 - 30,5
710/40 - 22,5	700/55 - 26,5	650/65 - 38	750/45 - 30,5
710/45 - 22,5	710/45 - 26,5	650/75 - 38	24,5 x 32
480/65 - 24	750/50 - 26,5	700/65 - 38	30,5 x 32
500/65 - 24	750/55 - 26,5	710/70 - 38	16,9 x 34
500/70 - 24	780/55 - 26,5	600/65 - 42	18,4 x 34
500/75 - 24	800/40 - 26,5	500/70 - 28	23,1 x 34
650/45 - 24,5	16,9 x 28	600/65 - 28	420/85 - 34
710/40 - 24,5	480/70 - 28	29,5 x 29	460/85 - 34
20,5 x 25	500/65 - 28	800/65 - 29	480/70 - 34
23,5 x 25	12,4x24	16,9 x 30	



Lanac sa pločicama, gusti, na upit

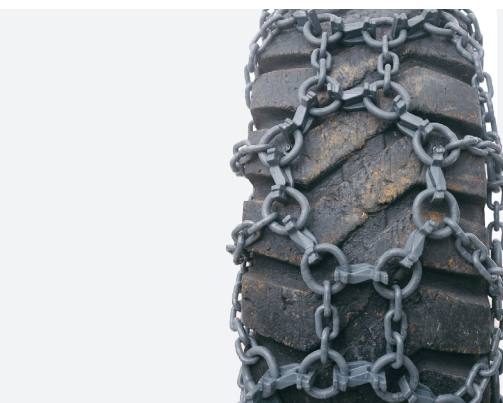

Lanac sa pločicama tip "O"



Kopitar gusti "multiring"

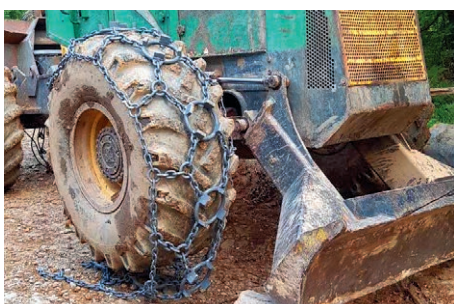

Jednostavna montaža



Mrežasti bodljikavac sa pločicama



Komplet - mehanizam za zatezanje

# 1. ČELIČNA UŽAD I LANCI

# Wire ropes and chains

## 1.15. Konopi

### Konop polyester PES pletenica

#### Standard polyester braid rope

Promjer (mm)	Prekidna sila (t)	Težina (g/m)
Diameter	BL	Weight
4	0,25	18
5	0,36	25
6	0,50	33
7	0,75	44
8	0,85	60
10	1,20	85
12	1,90	120
14	2,20	155
16	2,80	215
18	3,10	280
20	3,90	320
22	4,85	375
24	6,00	420
26	7,50	490
28	9,30	600
30	10,50	640

2.1 2.2 BL



- materijal: poliester
- konstrukcija: pletenica
- namjena: nautika, industrija, ribarstvo, građevinarstvo
- boja: bijela pletenica sa prošivima u 1 boji

### Konop polyester PES 3-struka

#### 3-strand twisted polyester rope

Promjer (mm)	Prekidna sila (t)	Težina (g/m)
Diameter	BL	Weight
6	0,65	30
8	0,90	49
10	1,41	77
12	2,05	100
14	2,60	130
16	3,58	177
18	4,35	218
20	5,65	280
22	6,23	320
24	7,47	400
26	8,96	450
28	11,0	550
30	12,0	610

2.1 2.2 BL

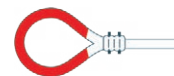

- materijal: poliester
- konstrukcija: 3 struka, Z-S
- namjena: nautika, sport, ribarstvo, građevinarstvo
- boja: bijela i crna, ostalo na upit

# 1. ČELIČNA UŽAD I LANCI

## Wire ropes and chains

### 1.15. Konopi

#### Konop polyamid 3-struka

3-strand polyamid rope nylon

2.1 2.2 BL

Promjer (mm)	Prekidna sila (t)	Težina (g/m)
Diameter	MBL	Weight
4	0,4	99
6	0,8	222
8	1,4	3,95
10	2,2	2,22
12	3,1	8,88
14	4,1	12,10
16	5,3	15,8
18	6,6	20,0
20	8,2	24,7
22	9,7	29,9
24	11,4	35,5
26	13,2	41,7
28	15,3	48,4
30	17,3	55,5
32	19,6	63,2
36	24,5	80,0

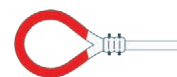

- materijal: polyamid/ nylon, multiflament
- ISO EN 1140
- konstrukcija: 3 struka
- namjena: nautika, ribarstvo, privezni konop, konop za vuču, građevinarstvo
- boja: bijela, ostalo na upit



#### Konop polyamid 8-struka

8-strand polyamid rope nylon

2.1 2.2 BL

Promjer (mm)	Minimalna prekidna sila (t)	Težina (g/m)
Diameter	MBL	Weight
20	8,2	0,25
22	9,6	0,29
24	11,4	0,36
26	13,2	0,417
28	15,3	0,49
30	17,3	0,56
32	20,4	0,64
36	25,5	0,81
40	30,6	1,0
44	36,2	1,21
48	43,4	1,44
52	51,0	1,70
56	57,1	1,90
60	64,3	2,26
64	72,4	2,57
68	81,4	2,86
72	91,8	3,25
76	100,5	3,57
80	114,2	4,01

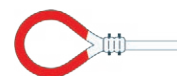

- materijal: polyamid/ nylon
- ISO EN 1140
- konstrukcija: 8 struka,
- namjena: nautika, ribarstvo, privezni konop, konop za vuču, građevinarstvo
- boja: bijela, ostalo na upit

# 1. ČELIČNA UŽAD I LANCI

## Wire ropes and chains

### 1.15. Konopi

#### Konop polypropylene 3-struka

##### 3-strand polypropylene rope

Promjer (mm)	Težina (kg/100m)	Minimalna prekidna sila (t)
Diameter	Weight	MBL
2,5	0,4	0,2
4	0,72	0,4
6	1,63	0,7
8	2,89	1,2
10	4,52	1,8
12	6,51	2,5
14	8,86	3,3
16	11,60	4,2
18	14,6	5,3
20	18,10	6,4
22	21,9	7,7
24	26,0	9,0
26	30,6	10,5
28	35,4	12,0
30	40,70	13,6
32	43,3	15,3
36	58,6	19,1
40	72,3	23,3

2.1 2.2 3.1 BL



- materijal: polypropilene
- ISO EN 1346
- konstrukcija: 3 struka,
- namjena: ribarstvo, privezni konop, konop za vuču
- boja: narančasta ili crna, ostalo na upit

#### Konop polypropylene 8-struka

##### 8-strand polypropylene rope 8-strand

Promjer (mm)	Težina (kg/100m)	Minimalna prekidna sila (t)
Diameter	Weight	MBL
20	18,1	6,4
22	21,9	7,7
24	26,0	8,9
26	30,6	10,3
28	35,4	11,8
30	40,7	13,5
32	46,3	15,3
36	58,6	19,1
40	72,3	23,3
44	87,5	28,5
48	104,0	33,5
52	122,0	38,9
56	142,0	44,7
60	163,0	50,8
64	185,0	57,2
68	210,0	64,3
72	234,0	71,3
76	262,0	79,1

2.1 2.2 3.1 BL

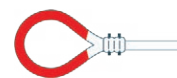

- materijal: polypropilene
- ISO EN 1346
- konstrukcija: 8 struka,
- namjena: ribarstvo, privezni konop, konop za vuču
- boja: narančasta ili crna, ostalo na upit



## **STONE COMPANY d.o.o.**

Centar vijčane robe – Vaš partner za kvalitetna  
montažna rješenja.

**Adresa:** Bubalo 6, Širitovci, 22320 Drniš

**Mobitel:** +385 (0)98 676 721

**Email:** [info@stonecompany.hr](mailto:info@stonecompany.hr)

